

Nanyang Primary School
Mathematics
Primary 2
Term 3 Combined Topical Test

Name: _____ () Marks: / 30

Class: Primary 2 () Parent's Signature: _____

Date: 23rd August 2017 (Wednesday) _____

Duration: 45 minutes

Section A

Questions 1 to 8 carry 1 mark each.

For each question, four options are given.

One of them is the correct answer.

Choose the correct answer and write its number (1, 2, 3 or 4) in the brackets () provided. (Total: 8 marks)

1. Look at the picture below.

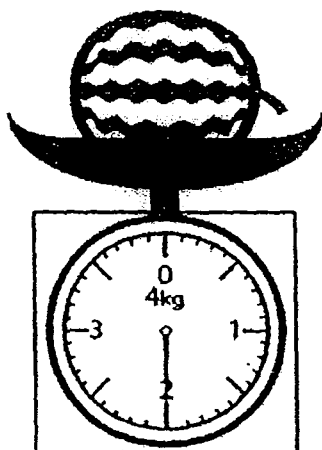

What is the mass of the watermelon?

- (1) 1 kg (2) 2 kg
(3) 3 kg (4) 4 kg ()

2. Look at the pictures below.

Basketball

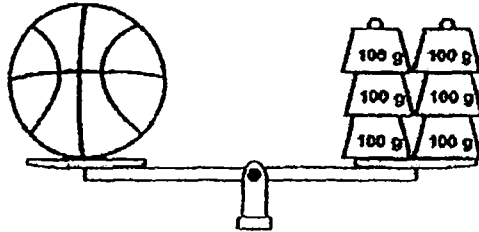

Beach ball

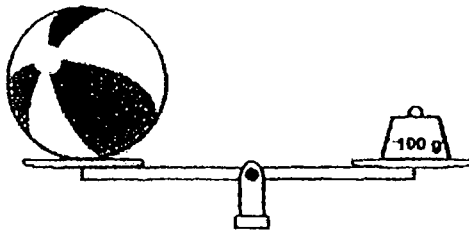

Soccer ball

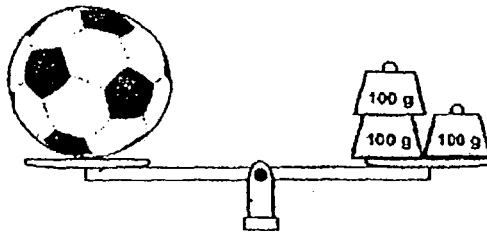

Volleyball

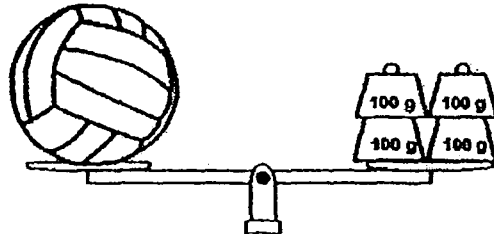

Which ball is the heaviest?

- (1) Basketball
- (3) Soccer ball

- (2) Beach ball
- (4) Volleyball

()

3. Look at the picture below.
The pizza was divided into 4 equal parts.

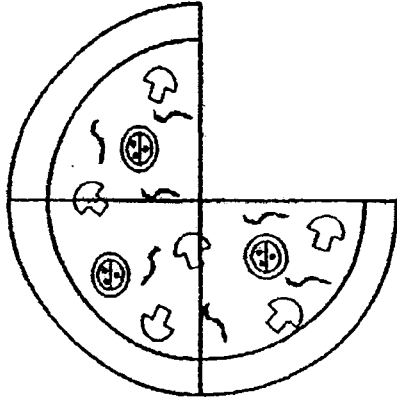

What fraction of the pizza was removed?

- (1) $\frac{4}{4}$ (2) $\frac{3}{4}$
 (3) $\frac{2}{4}$ (4) $\frac{1}{4}$ ()

4. Look at the picture below.

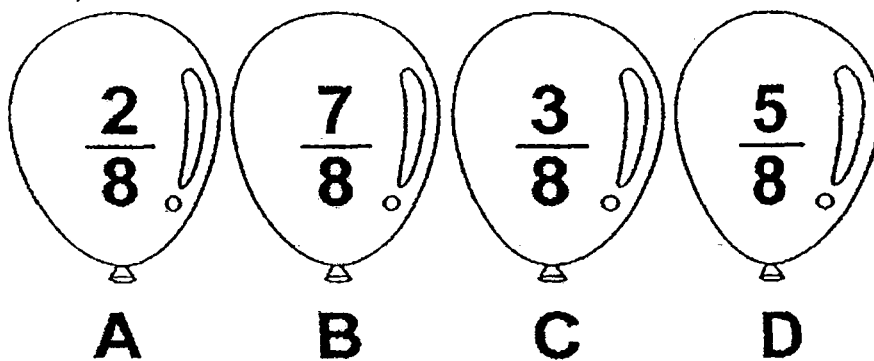

Which one of the balloons above show a fraction that is less than $\frac{3}{8}$?

- (1) D (2) C
 (3) B (4) A ()

5. What is the sum of $\frac{2}{4}$ and $\frac{1}{4}$?

(1) $\frac{1}{4}$

(2) $\frac{1}{8}$

(3) $\frac{3}{4}$

(4) $\frac{3}{8}$

()

6. Mr Chua goes to work at 30 minutes before 8 a.m. every day.

He takes half an hour to reach his office.

What time does Mr Chua reach his office?

(1) 7.30 a.m.

(2) 8.00 a.m.

(3) 8.30 a.m.

(4) 9.00 a.m.

()

7. The total mass of 3 sweets and 1 chocolate is 24 g.

The mass of the chocolate is 9 g.

What is the mass of a sweet?

(1) 5 g

(2) 6 g

(3) 8 g

(4) 15 g

()

8. Study the pattern below.

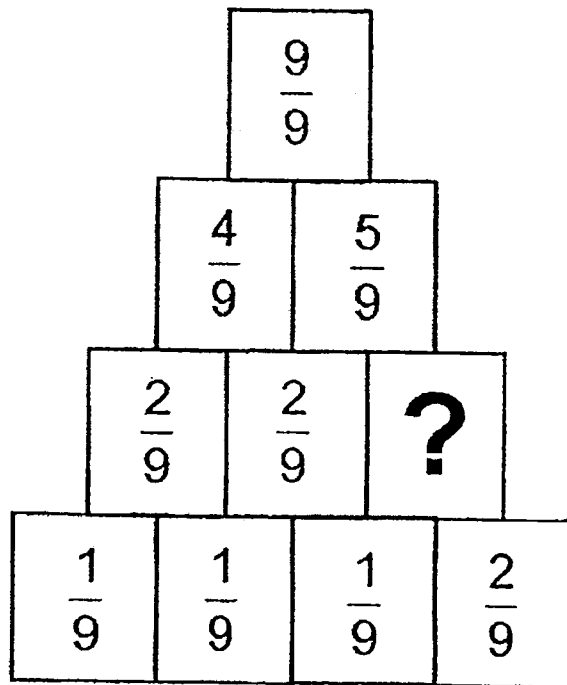

What is the missing fraction?

(1) $\frac{1}{9}$

(2) $\frac{2}{9}$

(3) $\frac{3}{9}$

(4) $\frac{4}{9}$

()

Section B

Questions 9 to 13 carry 2 marks each.

Show your working clearly in the space provided for each question and write your answer in the blank provided.

(Total: 10 marks)

9. Study the picture below.

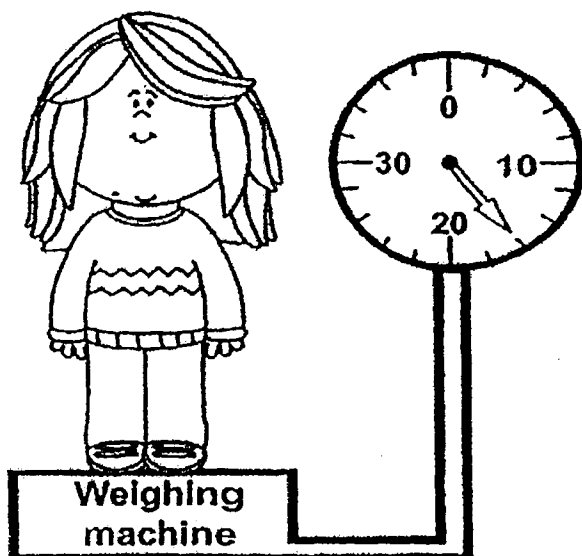

What is the mass of the girl?
Circle the correct answer below.

16 grams / 160 grams / 16 kilograms / 160 kilograms

10. Arrange the fractions below from the greatest to the smallest.

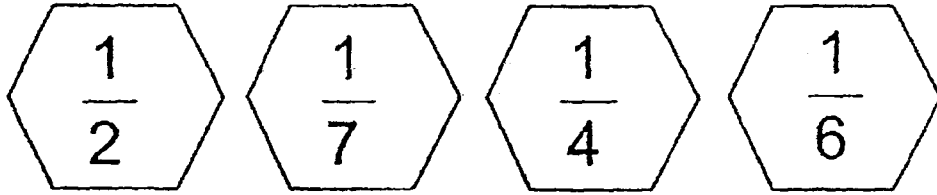

Write your answer in the shapes below.

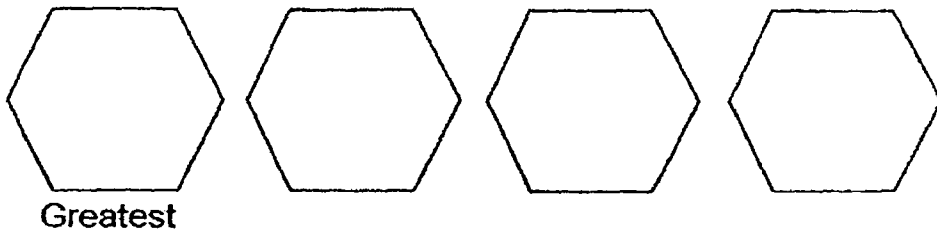

11. Only two of the following fractions add up to $\frac{6}{10}$.
Draw a line to join the two fractions to show your answer.

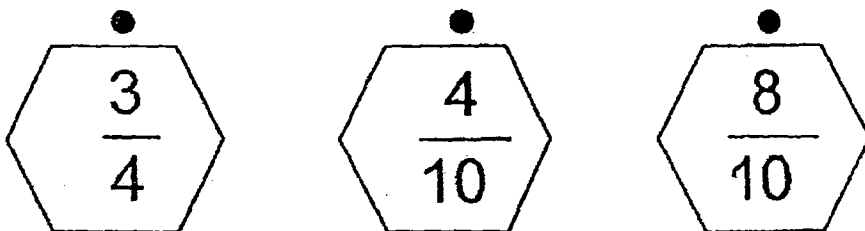
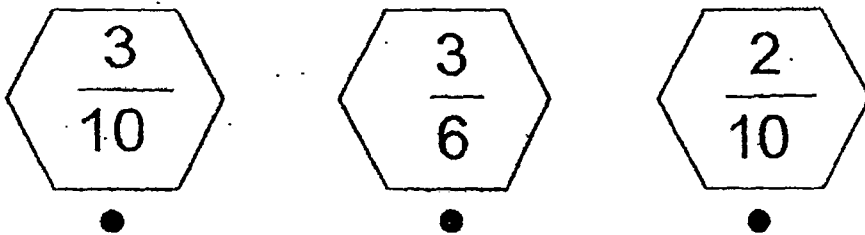

12. The clock below shows the time that Kavitha goes to bed at night.

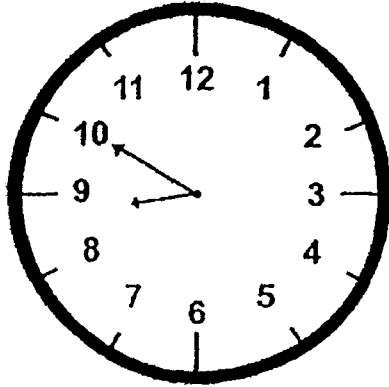

What time does Kavitha go to bed?

Ans: _____ p.m.

13. Study the TV Guide below.

Happy TV Guide	
7.00 a.m.	Benny Ten
7.30 a.m.	Spongebox Square Shorts
8.00 a.m.	Wind Club
8.30 a.m.	Wind Club
9.00 a.m.	Ginger Street

Which one of the television programmes lasted for 1 hour?

Ans: _____

Section C

Questions 14 to 16 carry 4 marks each.

Do these word problems carefully.

Show your working clearly in the space provided for each question.

(Total: 12 marks)

14. The total mass of Amanda and Blair was 50 kg.
Amanda had a mass of 24 kg.

(a) What was the mass of Blair?

The mass of Blair was _____ kg.

- (b) Amanda was 15 kg heavier than Chandra.
What was the mass of Chandra?

The mass of Chandra was _____ kg.

15. Alethea ended school at 1.30 p.m.
 She took 30 minutes to reach home.
 She took 1 hour to finish her lunch once she reached home.



Draw the hands on the clock faces given and write the time on the blank provided to show the time for each activity.

- a) What time did Alethea reach home?
 (Write the time using a.m. or p.m.)

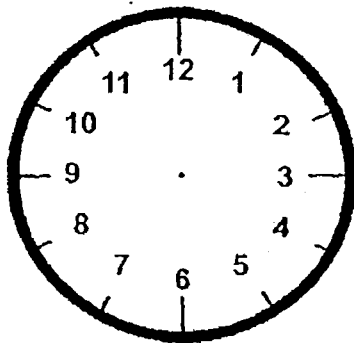

Alethea reached home at _____.

- b) What time did Alethea finish her lunch?
 (Write the time using a.m. or p.m.)

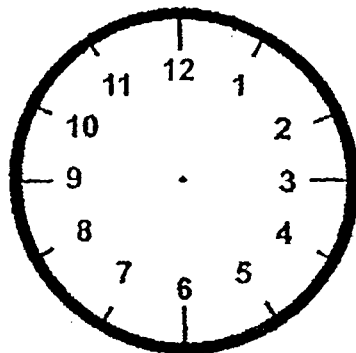

Alethea finished her lunch at _____.

16. Siti bought 6 pencils and erasers altogether.
The mass of each pencil was 3 g.
The mass of each eraser was 5 g.
The pencils and erasers weighed 22 g in total.

(a) How many pencils did Siti buy?

Siti bought _____ pencils.

- (b) Siti gave one pencil to her sister.
What was the total mass of the pencils and erasers left?

The total mass of the pencils and erasers left
was _____ g.

☺ *End of Paper* ☺
Please Check Carefully

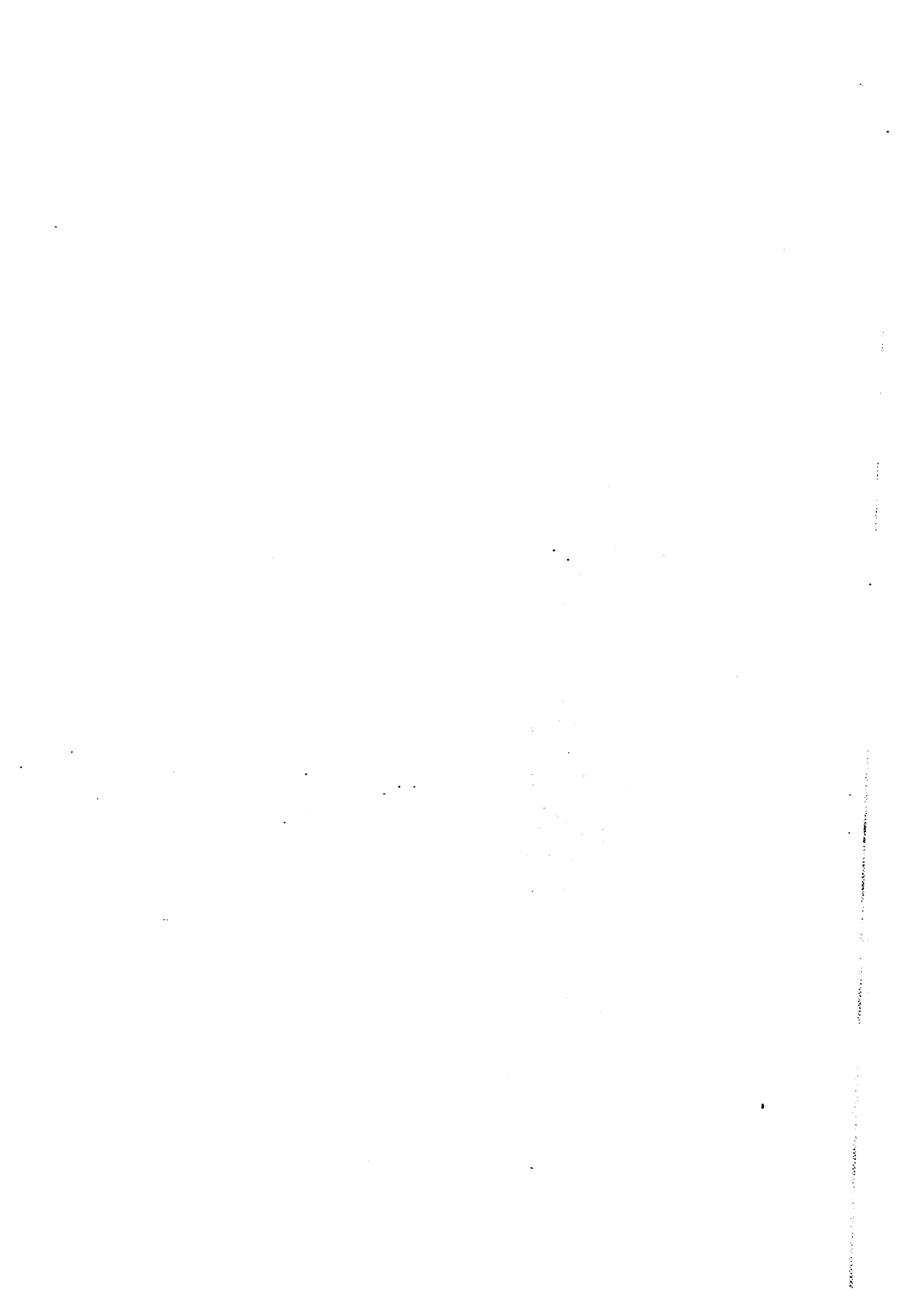

EXAM PAPER 2017(P2)

SCHOOL : NANYANG

SUBJECT : MATHEMATICS

TERM : CA2

Q1	Q2	Q3	Q4	Q5	Q6	Q7	Q8
2	1	4	4	3	2	1	3

9)16 kilograms 10) $\frac{1}{2}$, $\frac{1}{4}$, $\frac{1}{6}$, $\frac{1}{7}$ 11) $\frac{2}{10}$ ----- $\frac{4}{10}$

12)8.50 p.m. 13)Wind Club

14)a) $50 - 24 = 26$

The mass of Blair was 26 kg.

b) $24 - 15 = 9$

The mass of Chandra was 9 kg.

15)a)

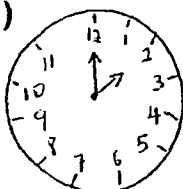

Alethea reached home at 2.00p.m.

b)

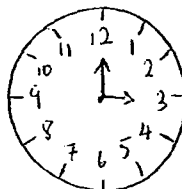

Alethea finished her lunch at 3.00p.m.

16)a) Siti bought 4 pencils.

$$b) 4 - 1 = 3$$

$$3 \times 3 = 9$$

$$2 \times 5 = 10$$

$$10 + 9 = 19$$

The total mass of the pencils and erasers left was 19 g.

Anglo-Chinese School (Junior)



SEMESTRAL ASSESSMENT 2 (2017)

PRIMARY 2 MATHEMATICS

Booklet A

Tuesday

31 October 2017

1 h

Name: _____ () Class: 2.() Parent's Signature _____

INSTRUCTIONS TO PUPILS

- 1 Do not turn over the pages until you are told to do so.
- 2 Follow all instructions carefully.
- 3 There are 26 questions in this booklet.
- 4 Answer ALL questions.

Section	Possible Marks	Marks Obtained
A	40	
B	40	
C	20	
Total	100	

This question paper consists of 17 printed pages (inclusive of cover page).

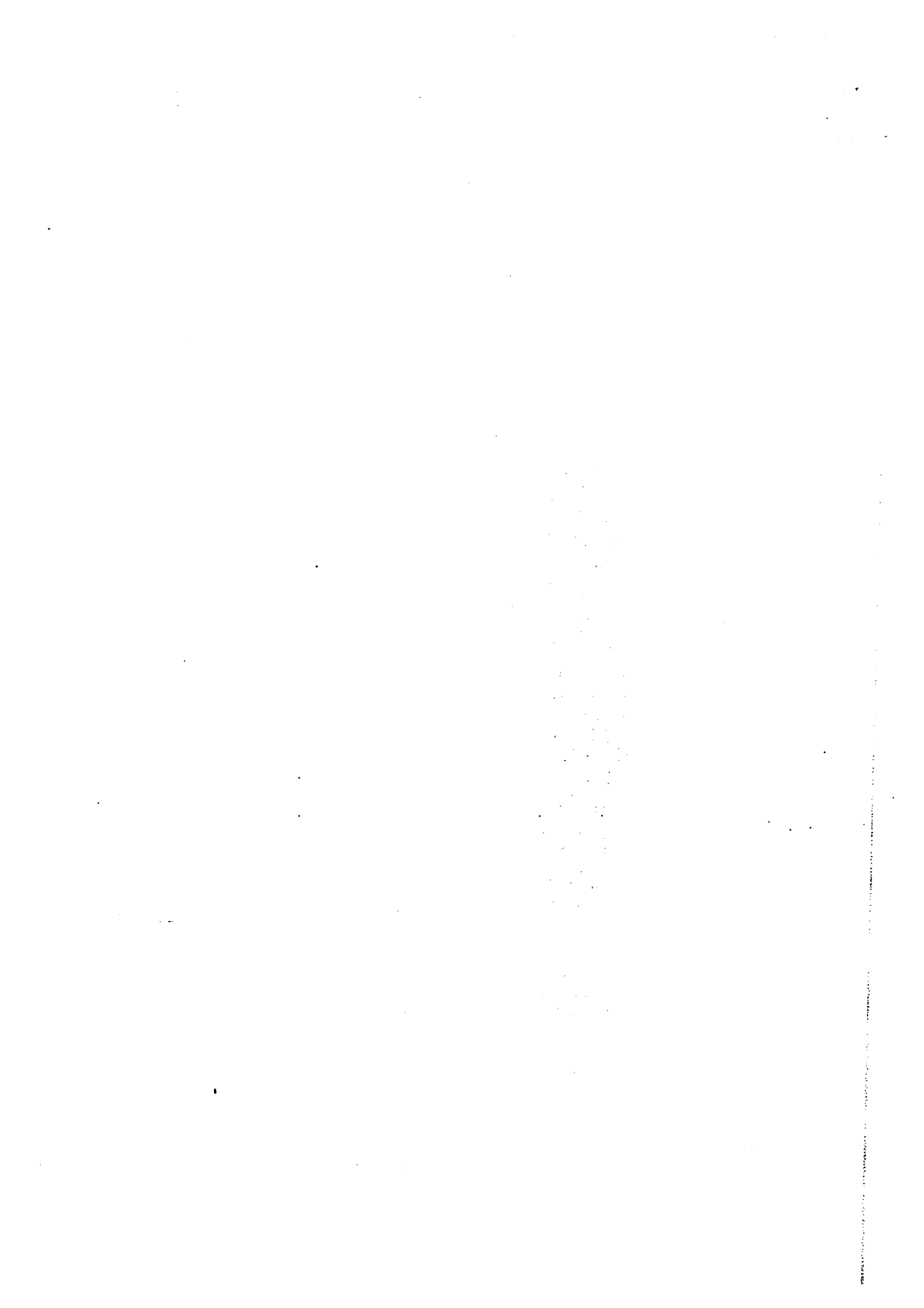

Section A

Questions 1 to 20 carry 2 marks each.

For each question, four options are given. One of them is the correct answer. Make your choice and write its number (1, 2, 3 or 4) in the brackets provided.

(40 marks)

1. What is five hundred and eighty-seven in numerals?

- 1) 578
- 2) 580
- 3) 587
- 4) 597

()

2. 10 tens + 7 ones = _____

- 1) 17
- 2) 107
- 3) 170
- 4) 1007

()

3. _____ is greater than 273 but smaller than 327.

- 1) 237
- 2) 271
- 3) 325
- 4) 372

()

Sub-Total :

4. Find the sum of 154 and 631.

- 1) 317
- 2) 477
- 3) 767
- 4) 785

()

5. 7 fours is the same as _____.

- 1) $7 + 4$
- 2) $4 + 4 + 4 + 4$
- 3) $4 + 4 + 4 + 4 + 4 + 4 + 4$
- 4) $7 \times 7 \times 7 \times 7$

()

6. 450¢ is the same as _____.

- 1) \$0.45
- 2) \$4.50
- 3) \$4.05
- 4) \$450

()

Sub-Total :

7. James, Peter, Henry and Lincoln went shopping. Each of them bought one of the toys shown below. Who spent the least amount of money?

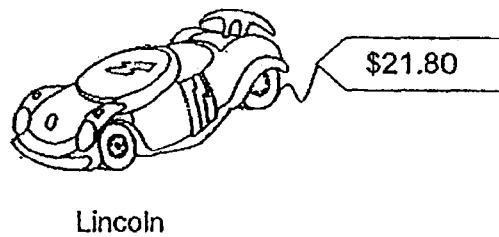
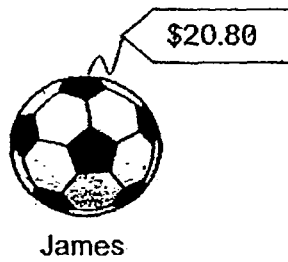
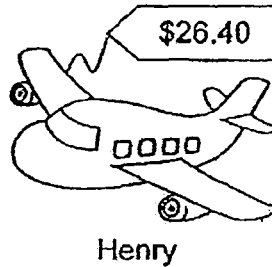
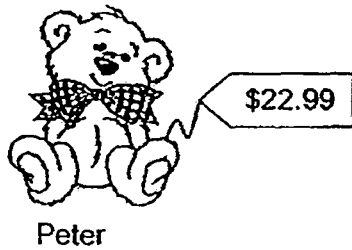

- 1) James
- 2) Peter
- 3) Henry
- 4) Lincoln

()

8. Alicia read some books in 16 days. She took 4 days to read each book. How many books did she read altogether?

- 1) 20
- 2) 12
- 3) 5
- 4) 4

()

Sub-Total :

9. Look at the shapes below.

Which shape has both curves and straight lines?

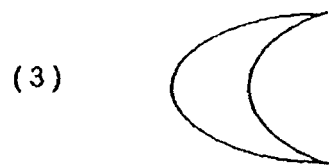
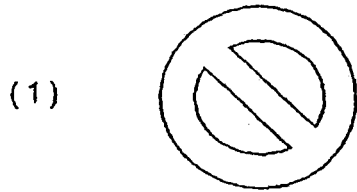

()

Sub-Total :

10. Which of the following figures has $\frac{5}{10}$ of its shape shaded?

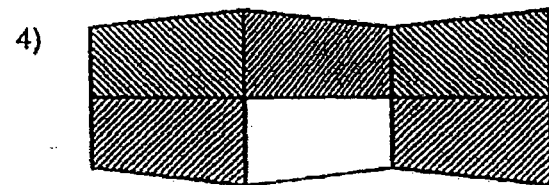
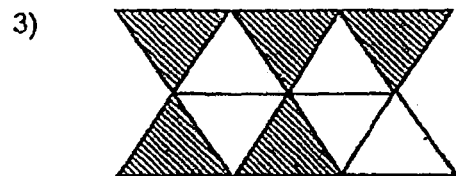
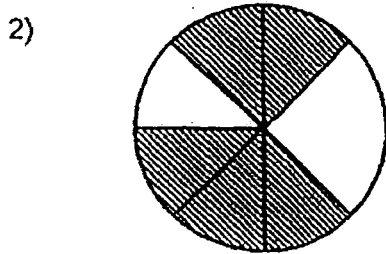
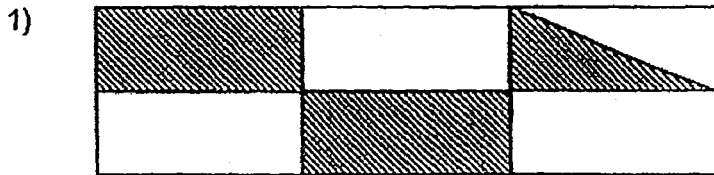

()

Sub-Total :

11. 4 5

 + 2 8 6

 7 3 1

What is the missing digit in the box?

- 1) 5
- 2) 2
- 3) 7
- 4) 4

()

12. Yoshio started eating his lunch at 12 noon. He took 30 minutes to finish eating. At what time did he finish eating his lunch?

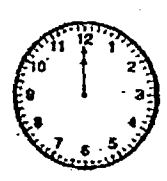

- 1) 11.30 a.m.
- 2) 12.30 a.m.
- 3) 11.30 p.m.
- 4) 12.30 p.m.

()

Sub-Total :

The picture graph below shows the number of children who play games at a party. Study the graph and answer Question 13.

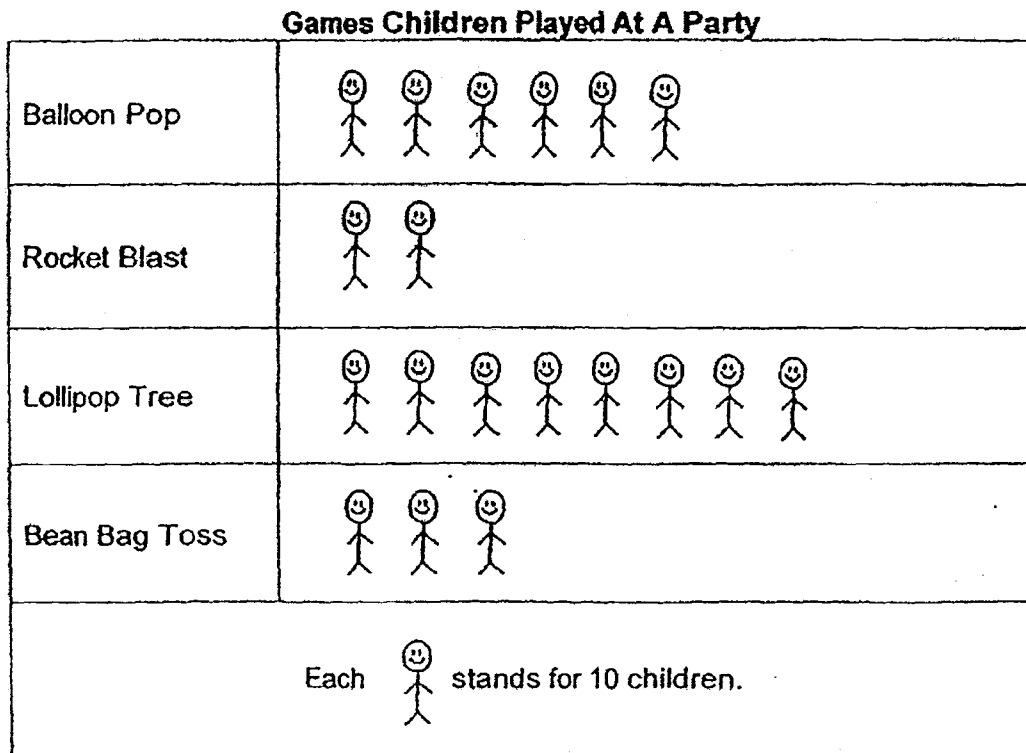

13. How many children played Rocket Blast and Lollipop Tree?

- 1) 80
- 2) 100
- 3) 110
- 4) 140

()

14. A sweet is 2 cm long.
A pair of scissors is as long as 4 sweets.
The total length of 2 pairs of scissors is _____ cm.

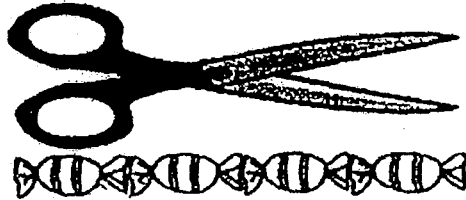

- 1) 16
- 2) 10
- 3) 8
- 4) 4

()

15. David bought 4 boxes of muffins. There were 8 muffins in each box.
How many muffins did David have?

- 1) 12
- 2) 2
- 3) 32
- 4) 4

()

16. Look at the pictures below.

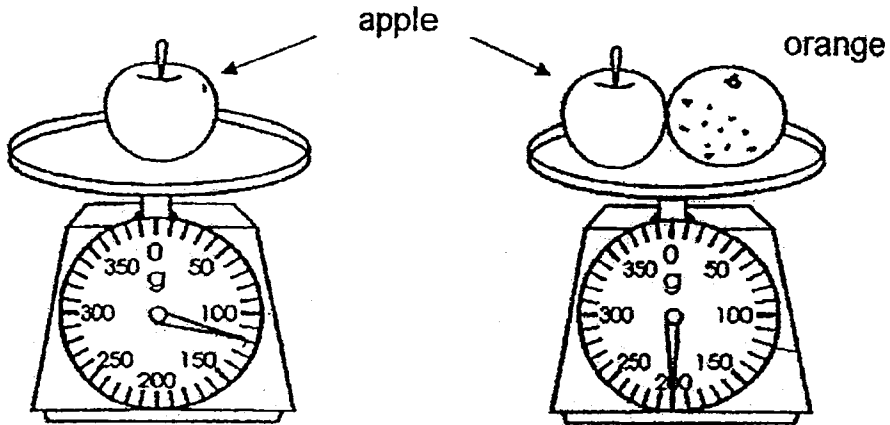

Find the mass of the orange.

- 1) 40 g
- 2) 80 g
- 3) 120 g
- 4) 200 g

()

17. Tristan bought some pens. 3 pens cost \$8. How much would 6 such pens cost?

- 1) \$16
- 2) \$18
- 3) \$24
- 4) \$48

()

Sub-Total :

18. Containers A, C and D are similar containers.
Which container has the least amount of water?

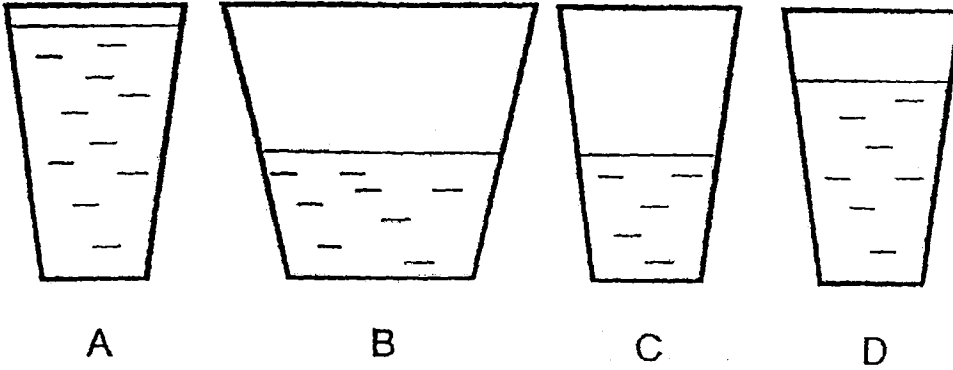

- 1) A
- 2) B
- 3) C
- 4) D

()

19. Karen had 20 pencils and some erasers. She packed 5 pencils and 2 erasers in each goodie bag. How many erasers did Karen pack in all the goodie bags?

- 1) 5
- 2) 2
- 3) 7
- 4) 8

()

20. What comes next in the pattern below?

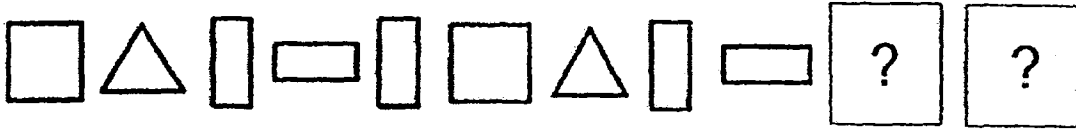

()

Section C

Questions 1 and 2 carry 2 marks each.

Questions 3 to 6 carry 4 marks each.

For each question, show your working clearly as marks will be given for working and relevant statements.

(20 marks)

1. Matthew collected 309 trading cards. He collected 152 more trading cards than Ken. How many trading cards did Ken collect?

Ken collected _____ trading cards.

2. Mrs Tan bought a pizza and cut it into 9 equal pieces. Her son ate 4 pieces. What fraction of the pizza was left?

_____ of the pizza was left.

--

3. Bernard had \$890. He spent \$114 on transport and \$378 on food.
(a) How much did he spend on transport and food altogether?

He spent \$ _____ on transport and food altogether.

- (b) How much had Bernard left?

He had \$ _____ left.

Sub-Total :

4. James has 320 sweets.
He gives away 5 sweets every day.

(a) How many sweets did he give away after 9 days?

He gave away _____ sweets after 9 days.

(b) How many sweets had James left after 9 days?

He had _____ sweets left after 9 days.

5. Mrs Lee went to watch a movie with her son and her 2 daughters.

(a) How much did the tickets for Mrs Lee's son and 2 daughters cost?

Movie Tickets	
Adult	Child
\$10	\$5

The tickets for the children cost \$_____.

(b) How much did Mrs Lee pay for all the tickets?

She paid \$_____ for all the tickets.

Sub-Total :

6. Mr Tan makes toasted bread for his customers.
Each customer orders 4 slices of toasted bread.

(a) If Mr Tan has 6 customers, how many slices of toasted bread must he make?

He must make _____ pieces of toasted bread.

(b) How many customers does Mr Tan have if he has to make 36 slices of toasted bread?

He has _____ customers.

End of Booklet A

Sub-Total

Anglo-Chinese School (Junior)



SEMESTRAL ASSESSMENT 2 (2017)

PRIMARY 2

MATHEMATICS

Booklet B

Tuesday

31 October 2017

50 min

Name: _____ () . Class: 2. ()

INSTRUCTIONS TO PUPILS

- 1 Do not turn over the pages until you are told to do so.
- 2 Follow all instructions carefully.
- 3 There are 20 questions in this booklet.
- 4 Answer ALL questions.

This question paper consists of 12 printed pages (inclusive of cover page).

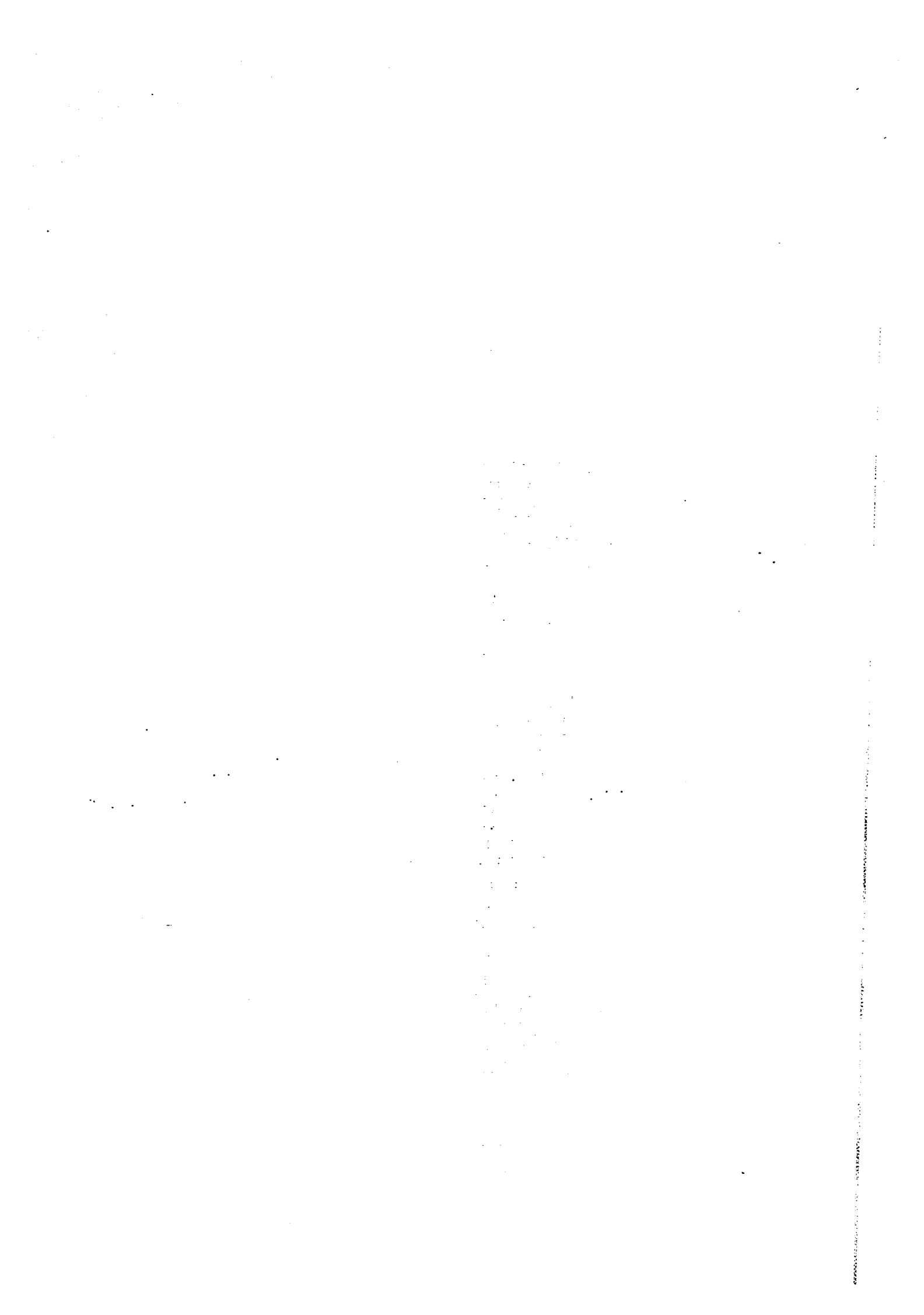

Section B

Questions 1 to 20 carry 2 marks each. Show your working clearly and write your answers in the boxes provided. For questions which require units, give your answers in the units stated.

(40 marks)

1. Arrange the numbers in order. Begin with the smallest.

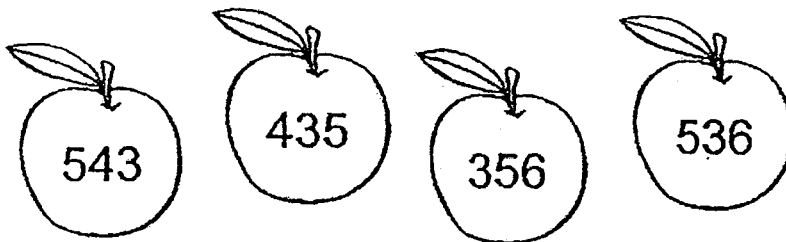

--	--	--	--

Smallest

2. The sum of two numbers is 796. One of the numbers is 344. What is the other number?

--

--

3. Find the answers for the sums below.

$$\begin{array}{r} \text{(a)} \quad 4 \ 9 \ 6 \\ + \quad 7 \ 8 \\ \hline \\ \hline \end{array}$$

$$\begin{array}{r} \text{(b)} \quad 2 \ 0 \ 7 \\ + \quad 1 \ 8 \ 6 \\ \hline \\ \hline \end{array}$$

4. Yummy Bakery baked 900 cakes on Monday. 121 of them were cheese cakes and the rest were chocolate cakes. How many chocolate cakes were baked?

5. $1 - \frac{3}{7} =$ _____

6. How many more boxes must be shaded so that $\frac{5}{8}$ of the figure is shaded?

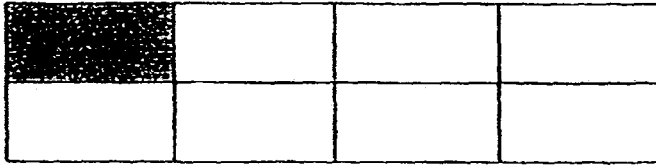

7. Jimmy has two \$50 notes, three \$10 notes and some coins shown below.
How much money does he have altogether?



8. What is the product of 10 and 10?

9. Eric has 40 sweets. He packs the sweets into bags. There are 5 sweets in each bag. How many bags does he need to pack all the sweets?

10. Vansen left for school at 6.30 a.m.
He took half an hour to walk from his house to school.



- (a) At what time did Vansen reach school?

 a.m.

- (b) Ron reached school 1 hour later than Vansen. At what time did Ron reach school?

 a.m.

11. What is the volume of water in the container?

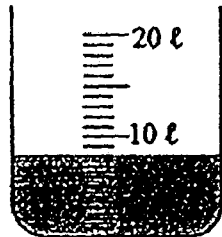

12. Look at the cuboid below. How many flat surfaces does it have?

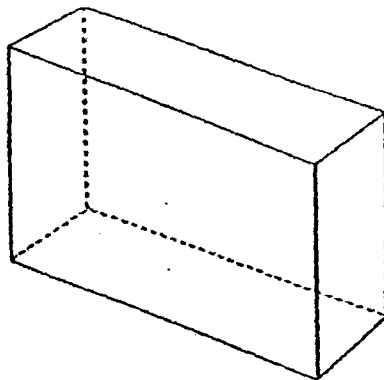

13. Write a division equation based on the pictures below.



_____ ÷ _____ = _____

14. What is the mass of 1 tennis ball?

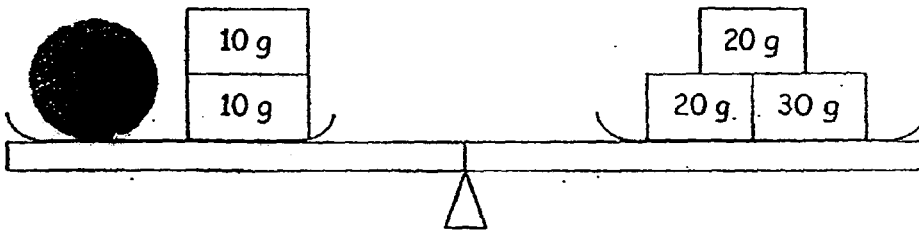

_____ g

15. Sally hung 5 lanterns from a ceiling. She placed Lanterns 1 to 4 equally apart from each other as shown in the diagram below. Study the diagram and answer the questions below.

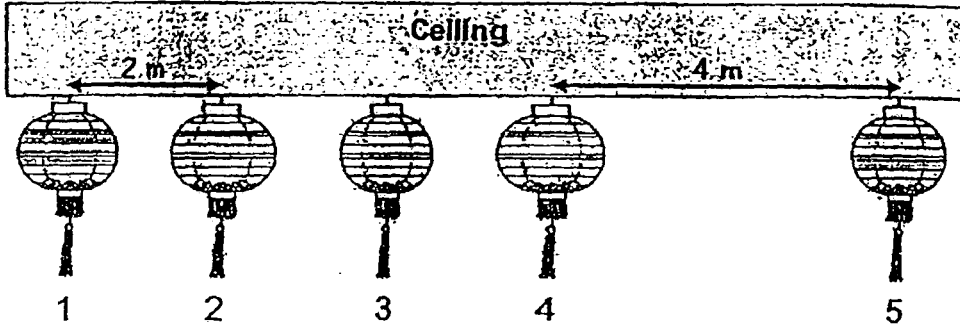

- (a) What was the distance between lantern 1 and lantern 4?

 m

- (b) Lantern 5 was placed 4 m away from Lantern 4.
What was the distance between lantern 1 and lantern 5?

 m

16. 3 cups of water can fill a jug completely. 24 cups of water can fill a tank completely. How many jugs of water are needed to fill the tank?

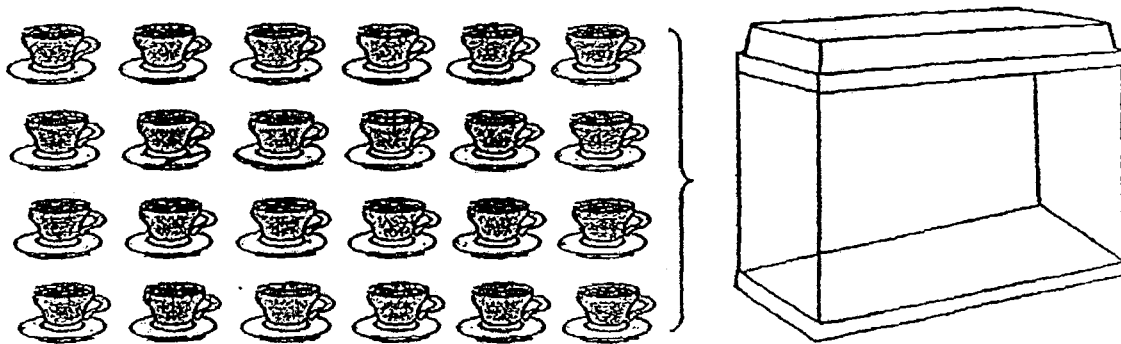

17. Mrs Tan bought 5 packets of cookies. There were 8 cookies in each packet. All the cookies were shared equally by her 4 children. How many cookies did each child get?

18. Circle the name of the object that was not used to form the figure below.

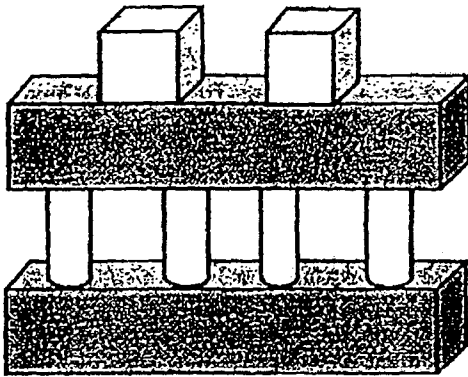

Name of Object
Cube
Cuboid
Cone
Cylinder

19. I am a 3-digit number.
The digit in the tens place is the number just after zero.
The digit in the hundreds place is 1 less than 10 and the digit in the ones place is 4 more than the digit in the tens place.
What number am I?

20. The picture graph below shows the number of goals 5 teams scored for a few soccer matches. The total score for the 5 teams is 54. Use the information given below to complete the graph.

Team E scored 2 more goals than Team B.
 Team C scored the least number of goals.

Number of goals scored by 5 teams

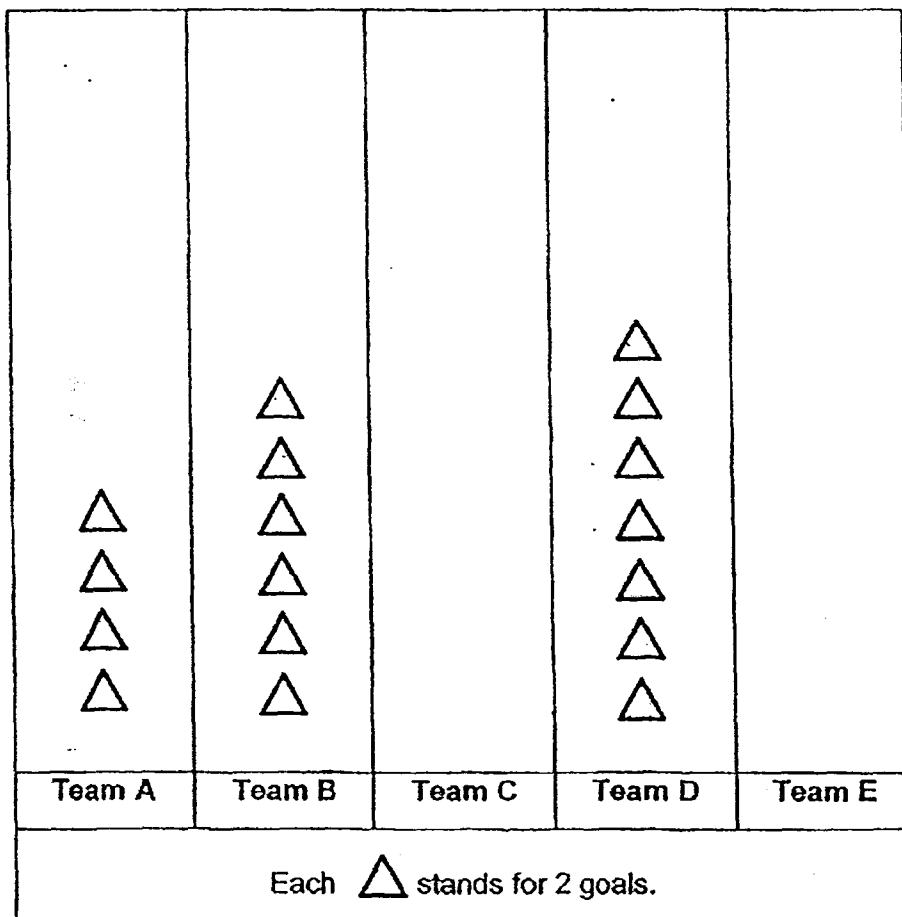

End of Booklet B

EXAM PAPER 2017(P2)

SCHOOL : ACS

SUBJECT : MATHEMATICS

TERM : SA2

Q1	Q2	Q3	Q4	Q5	Q6	Q7	Q8	Q9	Q10
3	2	3	4	3	2	1	4	1	3
Q11	Q12	Q13	Q14	Q15	Q16	Q17	Q18	Q19	Q20
4	4	2	1	3	2	1	3	4	3

Section C

1) $309 - 152 = 157$

Ken collected 157 trading cards.

2) $9/9 - 4/9 = 5/9$

5/9 of the pizza was left.

3) a) $114 + 378 = 492$

He spent \$492 on transport and food altogether.

b) $810 - 492 = 398$

He had \$398 left.

4)a) $9 \times 5 = 45$

He gave away 45 sweets after 9 days.

b) $320 - 45 = 275$

He had 275 sweets left after 9 days.

5)a) $5 \times 3 = 15$

The tickets for the children cost \$15

b) $10 + 15 = 25$

She paid \$25 for all the tickets.

6)a) $6 \times 4 = 24$

He must make 24 pieces of toasted bread.

b) $36 \div 4 = 9$

He has 9 customers.

Blooket B

1) 356 , 435 , 536 , 543

2) 452

3)a) 574

b) 393

4) 779

5) 4/7

6) 4

7) \$131.45

8) 100

9) 8

10)a)7.00a.m

b)8.00a.m

11) 8 litres

12)6

13) $12 \div 4 = 3$

14)50g

15)a)6m

b)10m

16)8

17)10

18)cone

19)915

20)Team C:▲▲▲

Team E :▲▲▲▲▲▲▲

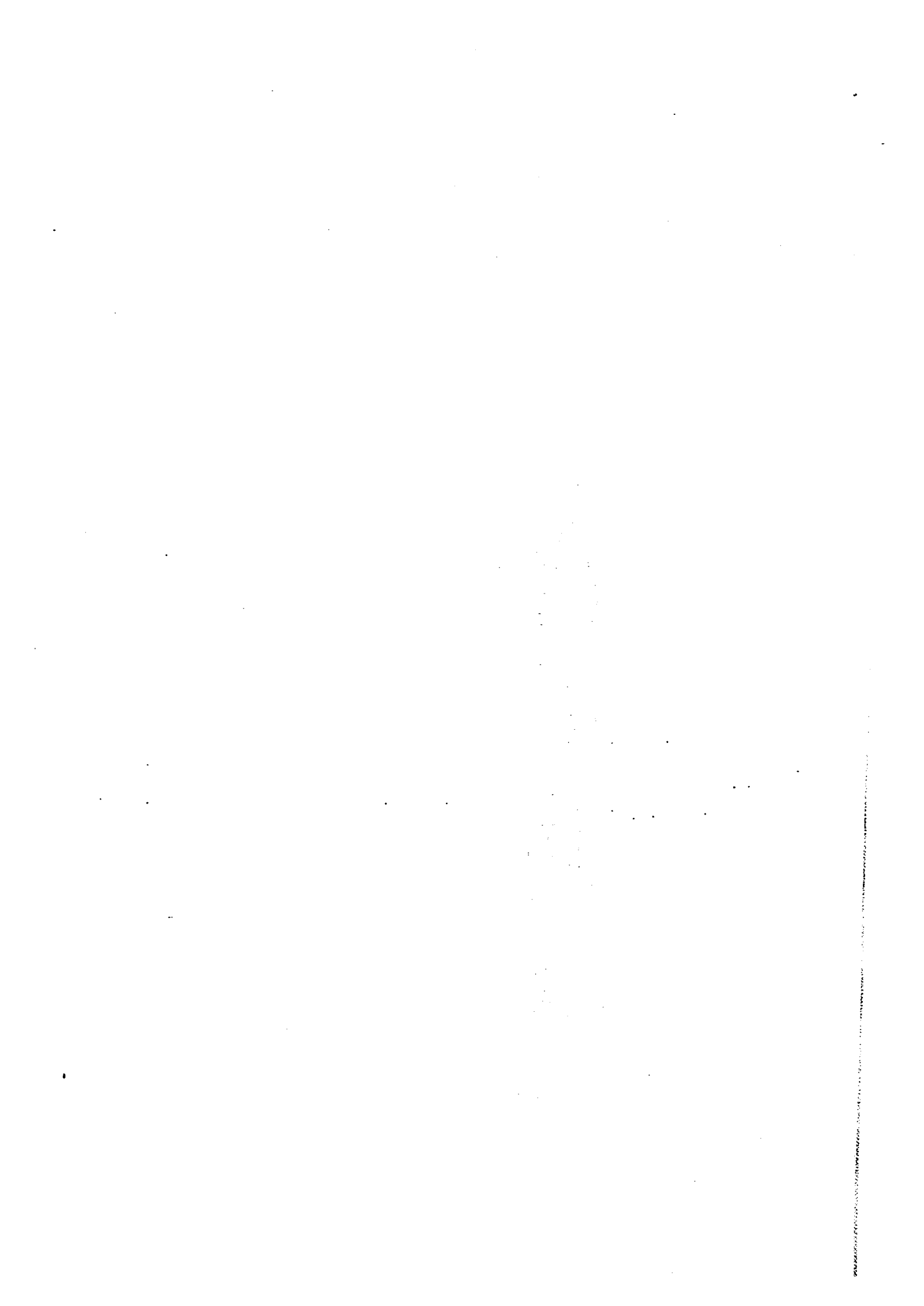



CATHOLIC HIGH SCHOOL
SEMESTRAL ASSESSMENT (2017)
PRIMARY TWO
MATHEMATICS

Name : _____ ()

Class : Primary 2 _____

Date : 30 October 2017

Duration : 1 h 30 min

Parent's Signature: _____

Section A	15
Section B	20
Section C	15
Total Marks	50

INSTRUCTIONS TO CANDIDATES

Do not turn over this page until you are told to do so.

Follow all instructions carefully.

Answer all questions.

Write all answers in this booklet.

This booklet consists of 18 printed pages excluding the cover page.

Vertical text or scanning artifact on the right edge of the page.

Section A: (15 marks)

Questions 1 to 15 carry 1 mark each. For each question, four options are given. One of them is the correct answer. Make your choice (1, 2, 3 or 4). All diagrams are not drawn to scale.

1. 5 hundreds and 9 ones is the same as _____.

(1) 59

(2) 509

(3) 590

(4) 591

()

2. Look at the number pattern below.

What number comes next?

731, 729, _____, 725, 723, 721

(1) 724

(2) 726

(3) 727

(4) 728

()

3. Which of the following numbers is an odd number?

(1) 124

(2) 214

(3) 241

(4) 412

()

4. What is the difference in value between 600 and 380?

(1) 220

(2) 320

(3) 380

(4) 980

()

5. What is the missing number?

$$\begin{array}{r} \\ 3 2 8 \\ 5 7 4 \\ \hline 9 \boxed{?} 2 \\ \hline \end{array}$$

(1) -1

(2) 0

(3) 5

(4) 9

()

6. Study the pattern below.



What is the next figure in the pattern?

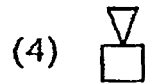
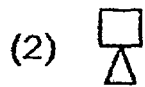

()

7. Kelly packed 36 stalks of roses equally into 4 boxes.

How many stalks of roses were there in each box?

(1) 8

(2) 9

(3) 32

(4) 40

()

8. The following figure is made up of 9 identical rectangles.
What fraction of the figure is shaded?



(1) $\frac{3}{6}$

(2) $\frac{6}{3}$

(3) $\frac{3}{9}$

(4) $\frac{6}{9}$

()

9. Which of the following list of numbers is arranged from the greatest to the smallest?

greatest

smallest

(1) 498, 489, 894, 849

(2) 489, 498, 849, 894

(3) 894, 489, 849, 498

(4) 894, 849, 498, 489

()

10. Study the diagram below. What is the total amount of money shown?



- (1) \$252.50
- (2) \$205.50
- (3) \$258.50
- (4) \$290.50

()

11. $12 \div 2$ is the same as $3 \times$?

(1) 6

(2) 2

(3) 3

(4) 4

()

12. What shapes is the figure below made up-of?

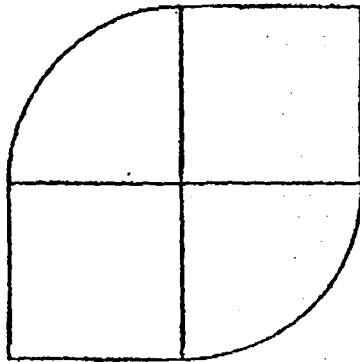

(1) 1 square and 1 quarter circle

(2) 2 squares and 2 quarter circles

(3) 4 quarter circles

(4) 4 squares

()

13. $\frac{7}{7} - \frac{1}{7} = \boxed{?}$

(1) $\frac{2}{7}$

(2) $\frac{6}{0}$

(3) $\frac{6}{7}$

(4) $\frac{8}{7}$

()

14. Which one of the following is likely to be the height of the flagpole at the parade square in a school?

(1) 5 m

(2) 5 cm

(3) 50 m

(4) 50 cm

()

15. Look at the diagram below.

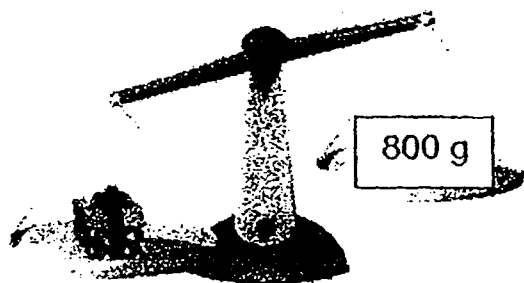

Box A

Which one of the following statements is true about the mass of box A?

- (1) The mass of box A is 800 g.
- (2) The mass of box A is less than 800 g.
- (3) The mass of box A is more than 800 g.
- (4) The mass of box A is more than 700 g but less than 800 g.

()

Section B: (20 marks)

Questions 16 to 25 carry 2 marks each. Show your working clearly and write your answers in the spaces provided. For questions which require units, give your answers in the units stated. All diagrams are not drawn to scale.

16. Write five hundred and forty-six in numerals.

Ans:

17. How many litres of water are there in the beaker?

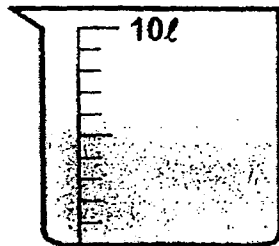

Ans:

 ℓ

18. Study the diagram below. Fill in the boxes with the correct numbers.

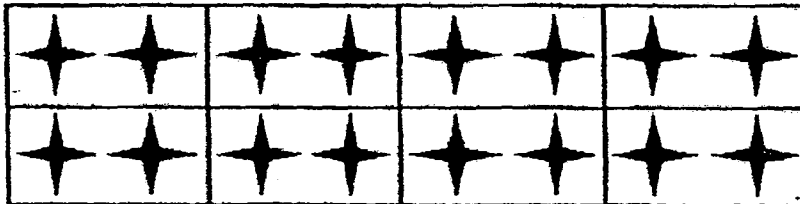

groups of 2 =

The picture graph below shows the number of stickers that 4 boys have. The number of stickers Junjie has is not shown in the picture graph. Study it carefully and answer questions 19 and 20.

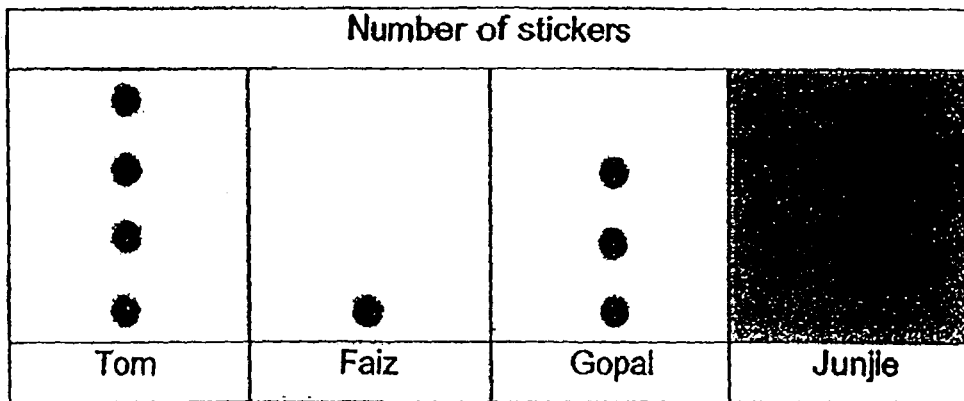

Each ● stands for 5 stickers.

19. How many stickers did Gopal have?

Ans:

20. Tom, Faiz and Junjie have 75 stickers altogether. How many stickers did Junjie have?

Ans:

21. Arrange the following fractions from the smallest to the greatest.

$$\frac{1}{4}, \frac{1}{10}, \frac{1}{2}$$

Ans:

_____ , _____ , _____

smallest greatest

22. Study the diagrams below.

Compare the masses of box B and box C.

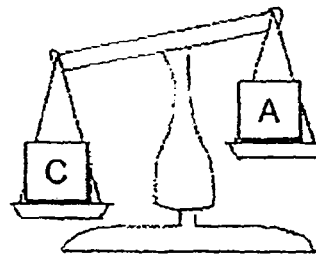
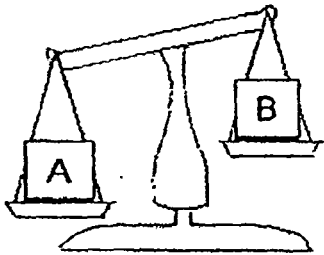

In the diagram below, write the letter B and C in the correct boxes to show the comparison in mass between B and C.

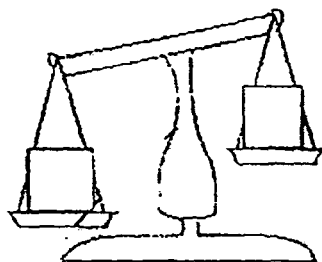

23. Study the picture carefully.

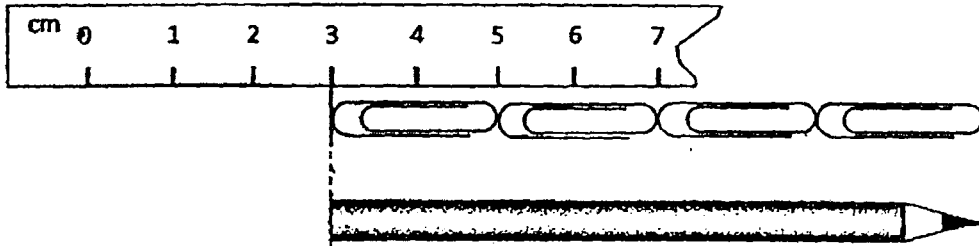

Based on the diagram of the ruler above, what is the length of the pencil?

Ans: cm

24. The clock below shows the time that Sulin reaches her home from school. What time does Sulin reach her home?

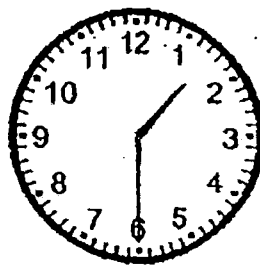

Ans: p.m.

25. Mrs Lee bought 2 bananas and 8 apples.
How much did she pay for the fruits?

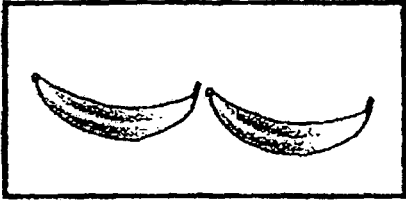

2 bananas for \$2

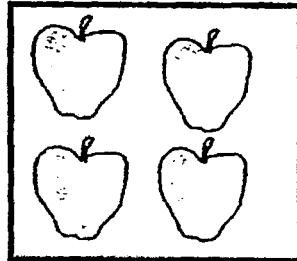

4 apples for \$3

Ans: \$

Section C: (15 marks)

Questions 26 to 30 carry 3 marks each. Show your working clearly and write your answers in the spaces provided. For questions which require units, give your answers in the units stated. All diagrams are not drawn to scale.

26. Ramu has 367 erasers.
Ahmad has 118 more erasers than Ramu.
How many erasers do the boys have altogether?

The boys have _____ erasers altogether.

27. A baker baked 8 cakes in the morning.
She baked thrice as many cakes in the afternoon.
How many cakes did the baker bake altogether?

She baked _____ cakes altogether.

28. Mrs Tan had 250 cm of string.
She used 180 cm of it to tie a parcel.
She cut the rest of the string equally into 10 shorter pieces.
How long was each shorter piece of string?

Each shorter piece of string was _____ cm long.

29. A full bottle can hold 2 l of water. 5 such bottles of water fills an empty pail completely. How much water can 9 such pails hold?

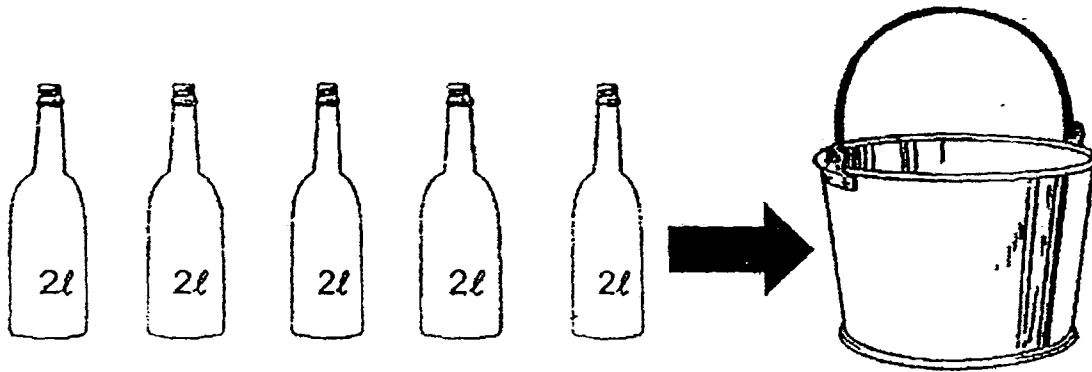

9 such pails can hold _____ l of water.

30. Mary spent \$31 at the supermarket.
She took out some ten dollar and five dollar notes from her purse to pay for the items at the cashier. She received \$4 change from the cashier.

(a) How much money did Mary take out from her purse?

Mary took out \$ _____ from her purse.

(b) How many ten dollar and five dollar notes did she take out from her purse?

List one possible number of ten dollar note and five dollar note.

Number of ten dollar note	Number of five dollar note

-End of paper-
Have you checked your work?

EXAM PAPER 2017(P2)

SCHOOL : CATHOLIC HIGH

SUBJECT : MATHEMATICS

TERM : SA2

Q1	Q2	Q3	Q4	Q5	Q6	Q7	Q8	Q9	Q10
2	3	3	1	2	1	2	4	4	3
Q11	Q12	Q13	Q14	Q15					
2	2	3	1	3					

16) 546

17) 6 L

18) 8 groups of 2 = 16

19) $3 \times 5 = 15$

20) $75 - 20 = 55$

21) $1/10, 1/4, 1/2$

22) C / B

$55 - 5 = 50$

23) 8 cm

24) 1.30 p.m.

25) \$8

26) $367 + 118 = 485$

$367 + 485 = 852$

The boys have 852 erasers altogether.

27) $8 \times 3 = 24$

$24 + 8 = 32$

She baked 32 cakes altogether.

28) $250 - 180 = 70$

$70 \div 10 = 7$

Each shorter piece of string was 7 cm long.

29) $5 \times 2 \text{ L} = 10 \text{ L}$

$10 \text{ L} \times 9 = 90 \text{ L}$

9 such pails can hold 90 L of water.

30) a) $\$31 + \$4 = \$35$

Mary took out \$35 from her purse.

b) $3 / 1$



HENRY PARK PRIMARY SCHOOL
2017 SEMESTRAL EXAMINATION 2
MATHEMATICS
PRIMARY 2

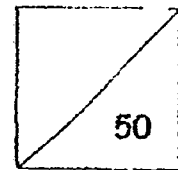

Name: _____ ()

Parent's Signature:

Class: Primary 2 _____

Duration of Paper: 1 h 30 min

Section A : Multiple Choice Questions (8 x 1 mark each = 8 marks)

Choose the correct answer and write its number in the brackets provided.

1. What is the difference between 364 and 502?

(1) 138

(2) 148

(3) 248

(4) 262

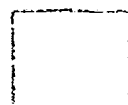

2. What is the value of 4 tens 23 ones?

- (1) 27
- (2) 63
- (3) 423
- (4) 671

3. Mrs Lee bought 5 boxes of cupcakes. There are 4 cupcakes in each box. Which of the following shows the total number of cupcakes Mrs Lee bought?

- (1) $5 + 4$
- (2) $5 - 4$
- (3) 5×4
- (4) $5 \div 4$

4. Marcus took half an hour to complete his homework. He started doing his homework at 11.50 a.m. What time did Marcus complete his homework?

- (1) 11.20 a.m.
- (2) 11.20 p.m.
- (3) 12.20 a.m.
- (4) 12.20 p.m.



5. Which of the following objects has more than 2 flat surfaces?



A

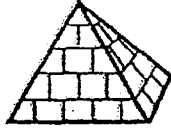

B

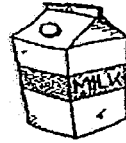

C



D

- (1) A and B
- (2) B and C
- (3) C and D
- (4) D and A

6. Look at the items below.

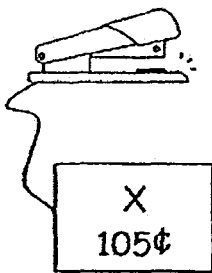

X
105¢



Y
65¢

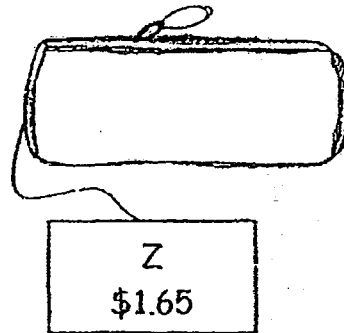

Z
\$1.65

Arrange them according to their prices shown, beginning with the cheapest item.

- (1) Y, X, Z
- (2) Y, Z, X
- (3) Z, X, Y
- (4) Z, Y, X

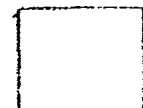

7. What is the mass of the pair of scissors shown below?

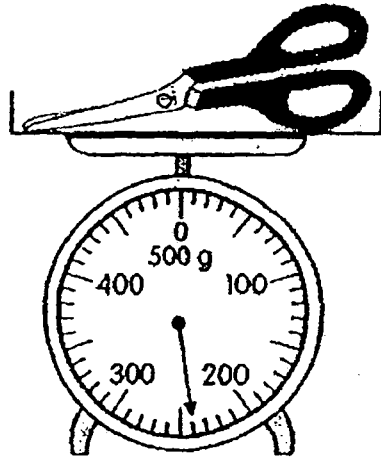

- (1) 204 g
- (2) 240 g
- (3) 306 g
- (4) 360 g



8. Study the table given below.
Select the most appropriate heading for A and B.

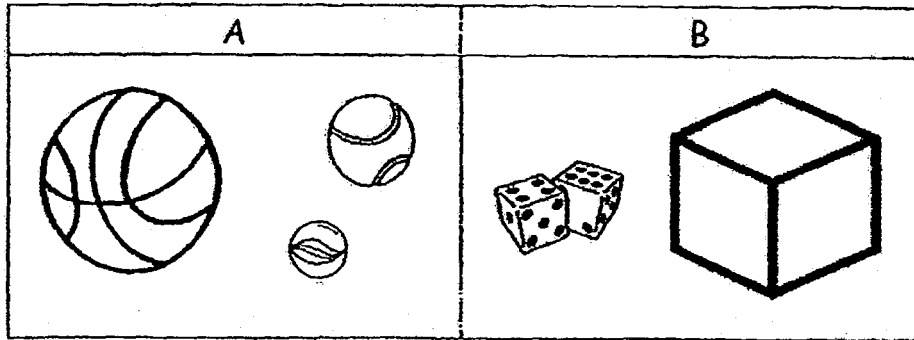

	A	B
(1)	cubes	cylinders
(2)	cubes	spheres
(3)	cylinders	cubes
(4)	spheres	cubes

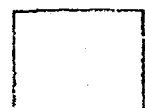

Section B : Open-Ended Questions (25 marks)

Questions 9 to 17 carry 1 mark each. Questions 18 to 25 carry 2 marks each. Read the following questions carefully and write your answers in the boxes or blanks provided. Show all your working clearly.

9. Put 12 muffins equally into 3 bags.
Circle the muffins to show the number of muffins in each bag.

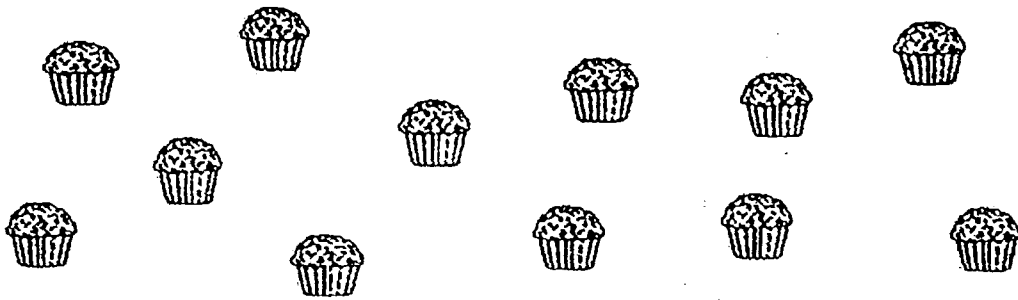

10. The table below shows Rachel's schedule on a Saturday morning.

Time	Activity
9.00 a.m. - 9.30 a.m.	Breakfast
9.30 a.m. - 10.00 a.m.	Homework
10.00 a.m. - 11.00 a.m.	Swimming
11.00 a.m. - 11.30 a.m.	Reading

Which activity did Rachel spend an hour on?

Ans:



11. Container A has 10 litres of water. Susan filled some bottles completely with all the water from Container A. From the bottles shown below, circle the bottles that Susan used to hold all the water from Container A.

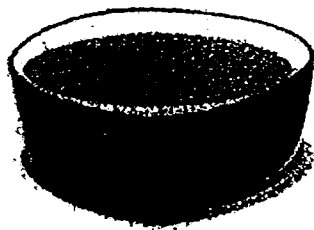

Container A
10 l

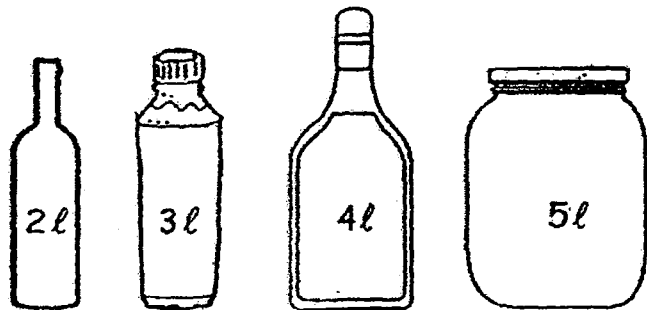

12. Study the pattern below.
Which is the missing solid in the pattern?



Circle the correct solid below to show your answer.

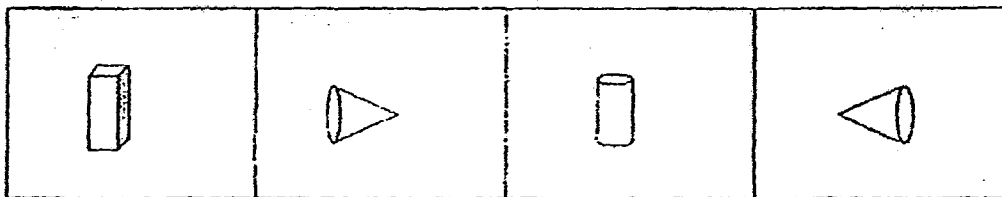

13. Which of the following figures, A or B, shows that $\frac{1}{4}$ of the figure is shaded?

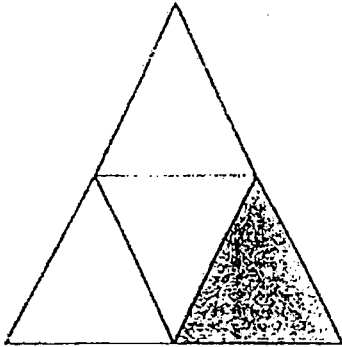

Figure A

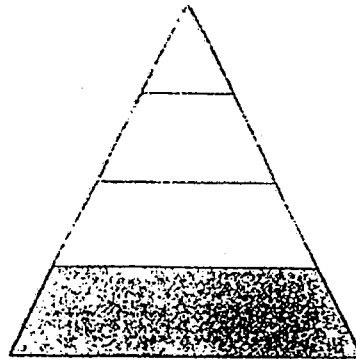

Figure B

Ans:

14. Gopal spent \$3 on food every day.
How much money would he spend on food in 7 days?

Ans:

15. What is the length of the pencil?

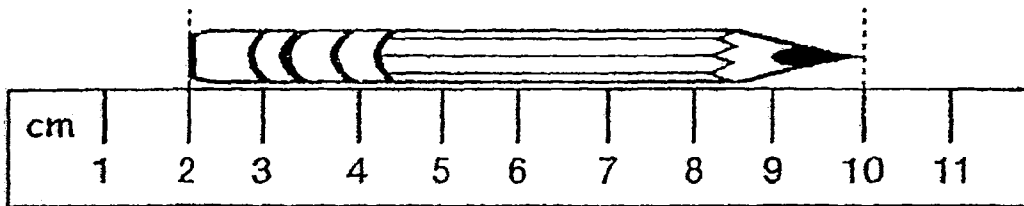

Ans:

 cm

16. Fill in the blank with 'g' or 'kg'.

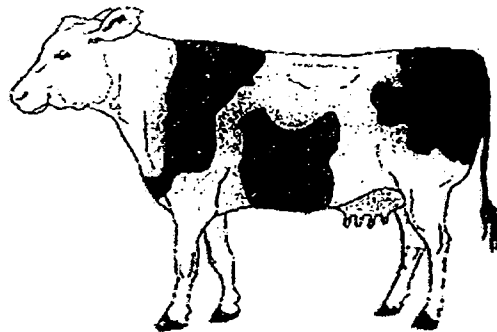

The mass of an adult cow is about 800 _____.

Ans:

17. What is 40 divided by 5?

Ans:

18. What is the sum of 789 and 39?

Ans:

19. Based on the picture given below, write a multiplication equation and a division equation in the boxes provided.

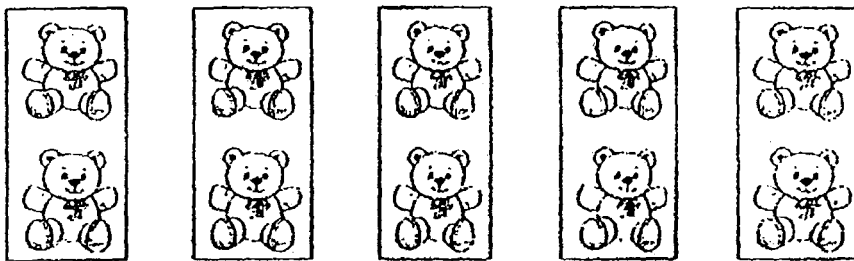

$$\square \times \square = \square$$

$$\square \div \square = \square$$

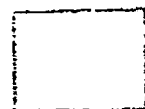

20. Study the picture graph below.

A total of 36 Primary 2 students visited the library on Monday.

How many students from Primary 2Q visited the library on Monday?

Draw  to complete the picture graph below.

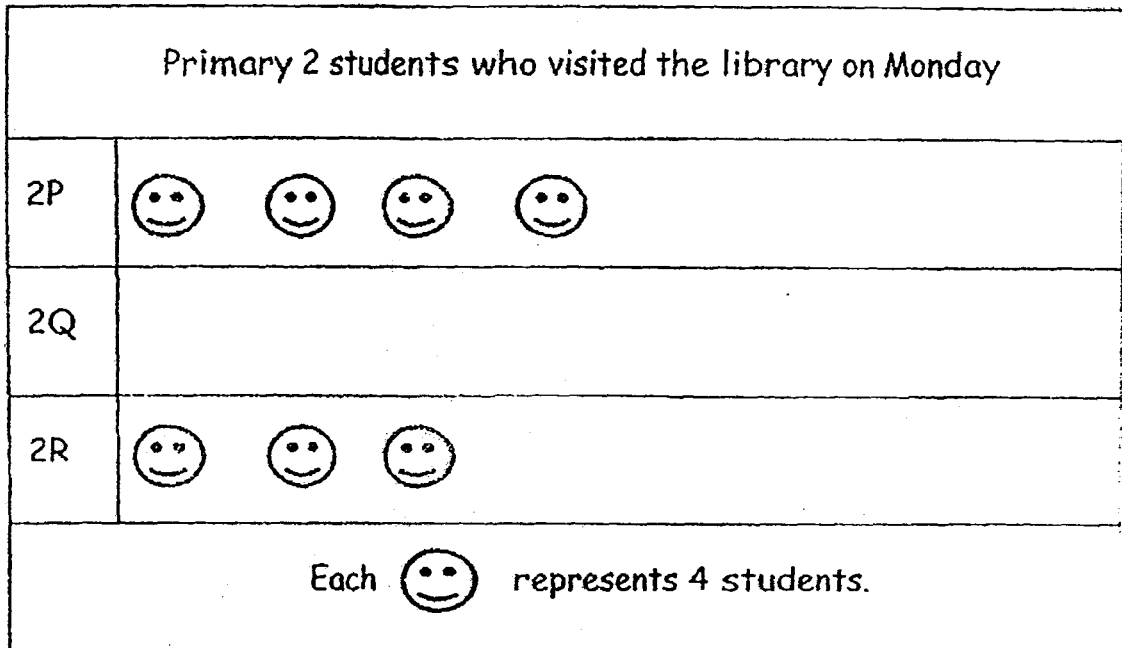

21. The picture graph below shows the number of students who bought food from the school canteen during recess.

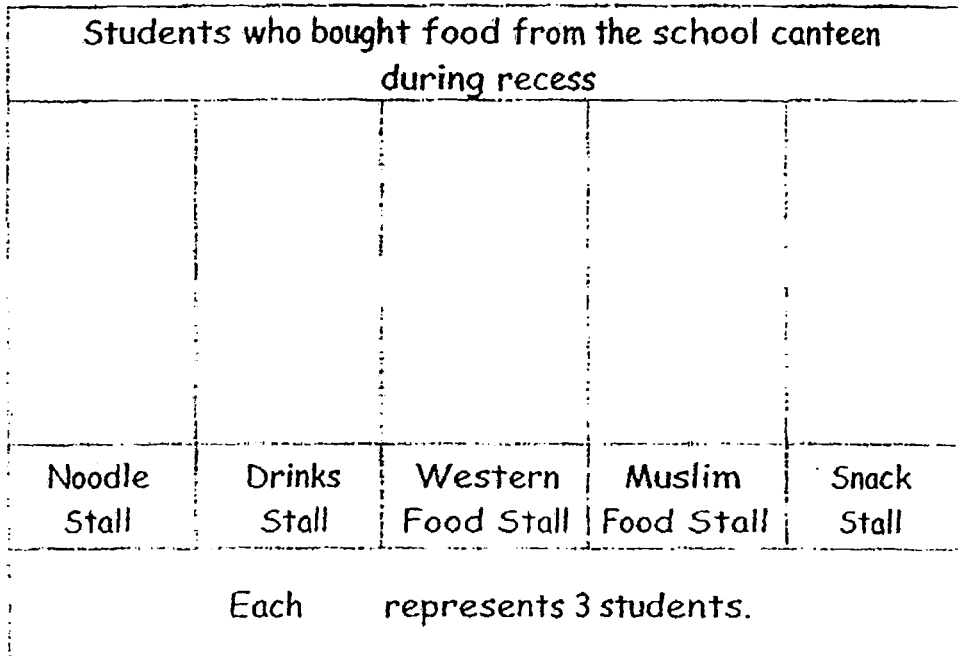

- a) How many fewer students bought food from the Snack Stall than from the Muslim Food Stall?

Ans:

- b) There were twice as many students who bought food from the Noodle Stall as from the _____ Stall.

Ans:

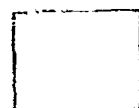

22. What is the smallest 3-digit odd number that can be formed with the cards below? Each digit can only be used once.

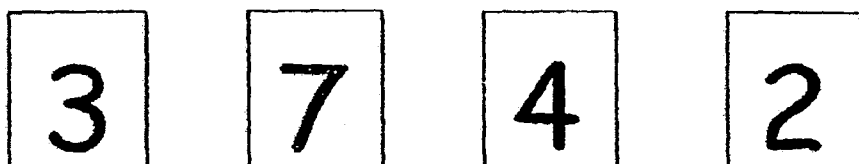

Ans:

23. Shannon wants to shade $\frac{7}{10}$ of the rectangle.
How many more parts does she need to shade?
Shade to show your answer.

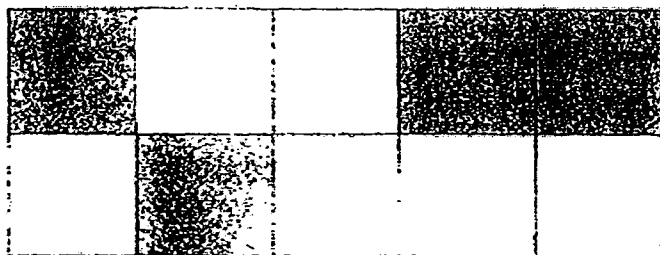

24. The amount of money Mei Mei has is shown in the box below.
She wants to buy a school bag which cost \$24.
How much more money does she need to buy the school bag?

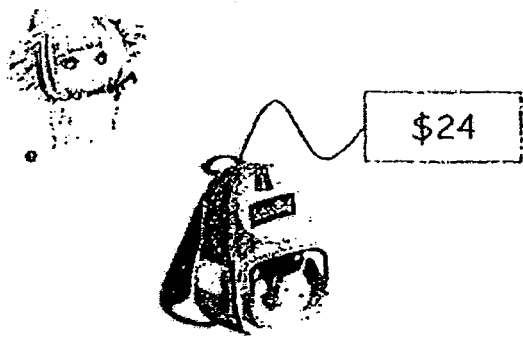
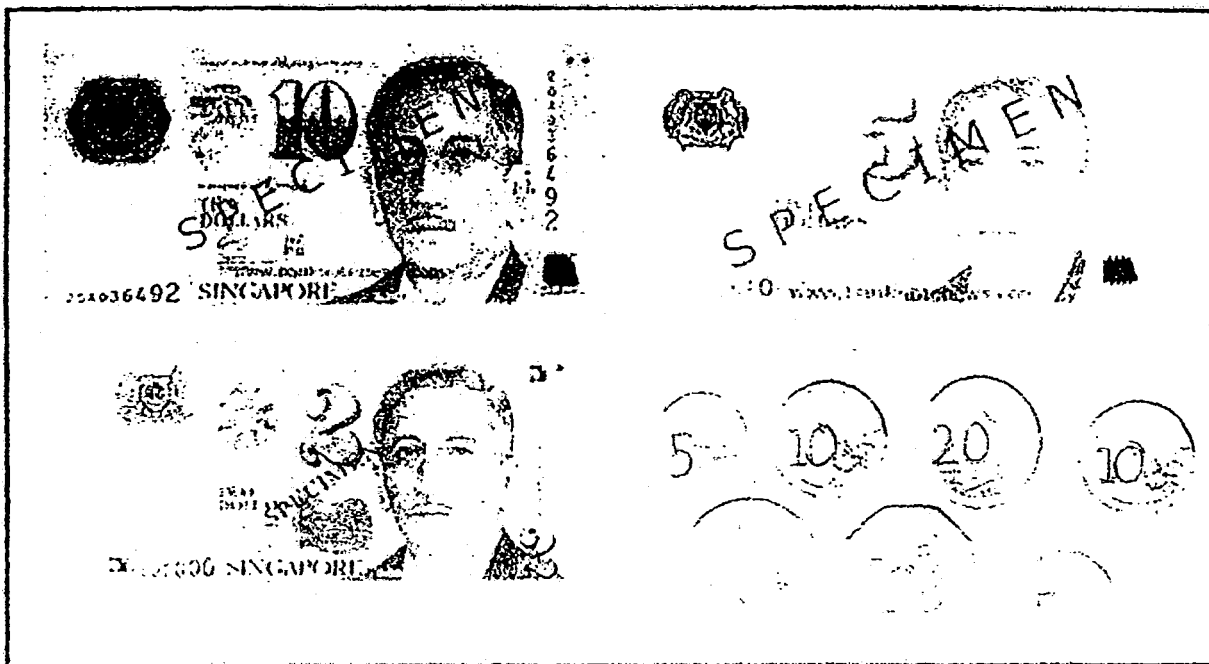

Ans: \$

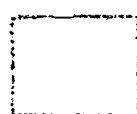

25. Find the missing digits A and B.

$$\begin{array}{r} 7 \square A 0 \\ - 5 9 7 \\ \hline \square B 0 3 \\ \hline \end{array}$$

Ans:

A is

B is



Section C : Word Problems (17 marks)

Questions 26 to 27 carry 4 marks each. Read each question carefully.
Show your equations and write your final answers in the blanks provided.

26. There were 538 mangoes and 379 apples at a fruit stall.

(a) How many more mangoes than apples were there?

Working

There were _____ more mangoes than apples.

(b) How many apples and mangoes were there altogether?

There were _____ apples and mangoes altogether.



27. Sue sews a total of 35 buttons on 5 dresses.
She sews an equal number of buttons on each dress.
Sue also sews 6 bows on each dress.

(a) How many buttons are there on each dress?

Working

There are _____ buttons on each dress.

(b) How many bows does Sue sew on 5 dresses?

Sue sews _____ bows on 5 dresses.



Questions 28 to 30 carry 3 marks each.

Read each question carefully. Show your equations and write your word statements clearly in the spaces provided.

28. Tom bought 10 packs of cards. There were 8 cards in each pack. He gave 26 cards to his friend. How many cards had Tom left?

Working



29. Rope A is 135 m long. Rope B is 118 m longer than Rope A.
Rope C is 57 m shorter than Rope B. What is the length of Rope C?

Working



30. A train carrying some passengers arrived at Station A. At Station A, only 27 passengers boarded the train. It then left for Station B. At Station B, only 59 passengers alighted from the train. When the train left Station B, there were 67 passengers on it. How many passengers were there on the train when it first arrived at Station A?

Working

-END OF PAPER-

Setters: Ms Rajesheela, Mr Saiful, Mr Warren Chao, Mrs Wong Ser Huay

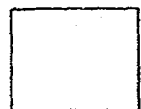

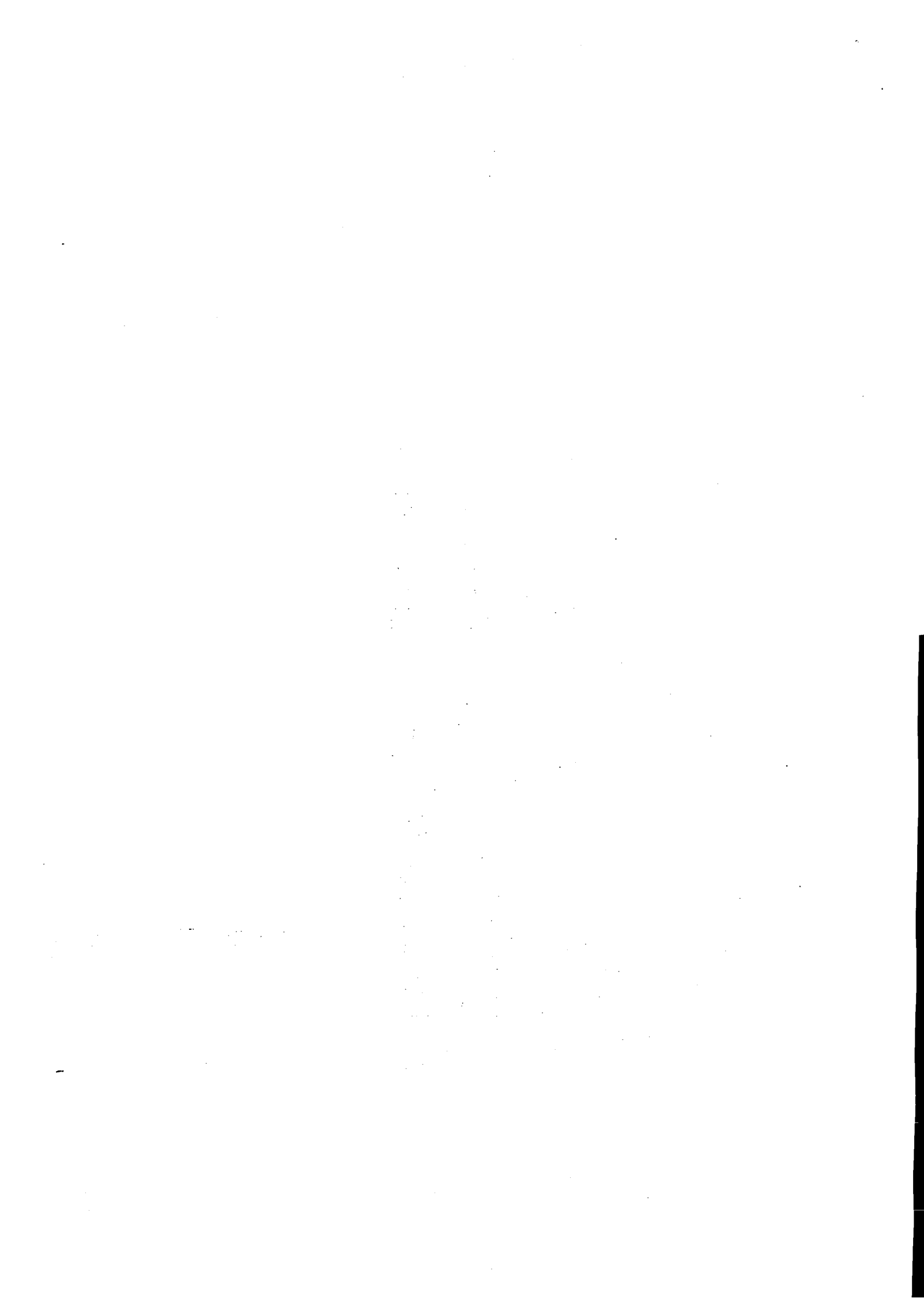

EXAM PAPER 2017(P2)

SCHOOL : HENRY PARK

SUBJECT : MATHEMATICS

TERM : SA2

Q1	Q2	Q3	Q4	Q5	Q6	Q7	Q8
1	2	3	4	2	1	2	4



10)Swimming

11)2L, 3L , 5L

12)

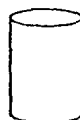

13)Figure A

14)\$21

15)8 cm

16)kg

17)8

18)828

19) $5 \times 2 = 10$

$10 \div 2 = 5$



21)a)9

b)Drinks

22)237

23)

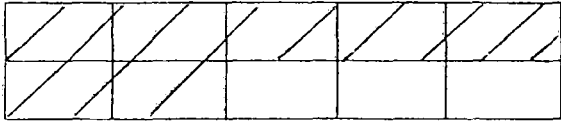

24) $\$24 - \$19 = \$5$

25) A is 0

B is 1

26)a) $538 - 379 = 159$

There were 159 more mangoes than apples.

b) $538 + 379 = 917$

There were 917 apples and mangoes altogether.

27)a) $35 \div 5 = 7$

There are 7 buttons on each dress.

b) $5 \times 6 = 30$

Sue sews 30 bows on 5 dresses.

28) $10 \times 8 = 80$

$80 - 26 = 54$

Tom had 54 cards left.

29) $135 + 118 = 253$

$253 - 57 = 196$

The length of Rope C is 196m long.

30) $67 + 59 = 126$

$126 - 27 = 99$

There were 99 passengers were on the train when the bus arrived station.



Maha Bodhi School
2017 End-of-Year Examination
Primary 2
Mathematics

Name : _____ ()

Class : Primary 2 _____

Date : 27 October 2017

Total Duration: 1 h 30 min

INSTRUCTIONS TO CANDIDATES:

1. Do not turn over this page until you are told to do so.
2. Follow all instructions carefully.
3. Answer all questions.
4. Write your answers in this booklet.

Section	Marks Obtained	Max Marks
A		20
B		20
C		10
Total		50

Parent's signature: _____

This booklet consists of 16 printed pages.

Section A: Multiple Choice Questions (20 marks)

Questions 1 to 8 carry 1 mark each.

Questions 9 to 14 carry 2 marks each.

For each question, four options are given. One of them is the correct answer.

Make your choice (1, 2, 3 or 4) and write your choice in the bracket () provided.

1. Which one of the following numbers has 6 in the tens place?

(1) 936

(2) 693

(3) 639

(4) 369

2. $702 =$ _____

(1) $70 + 2$

(2) $70 + 20$

(3) $700 + 2$

(4) $700 + 20$

3. 4 groups of 5 is the same as _____.

(1) $4 + 5$

(2) $4 + 4 + 4 + 4$

(3) $5 + 5 + 5 + 5$

(4) $5 + 5 + 5 + 5 + 5$

4. What fraction of the figure is shaded?

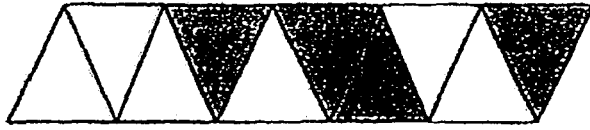

(1) $\frac{4}{10}$

(2) $\frac{6}{10}$

(3) $\frac{4}{6}$

(4) $\frac{6}{4}$

5. What is the time shown on the clock?

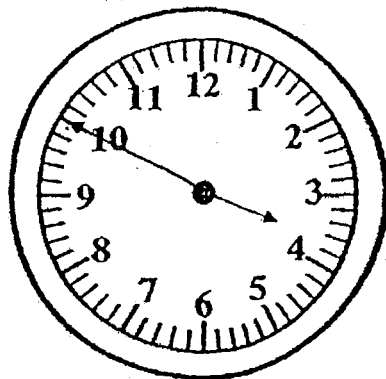

(1) 3.50 p.m.

(2) 4.50 p.m.

(3) 10.15 p.m.

(4) 10.20 p.m.

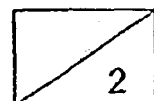

6. The picture graph below shows the number of stickers each child gets.

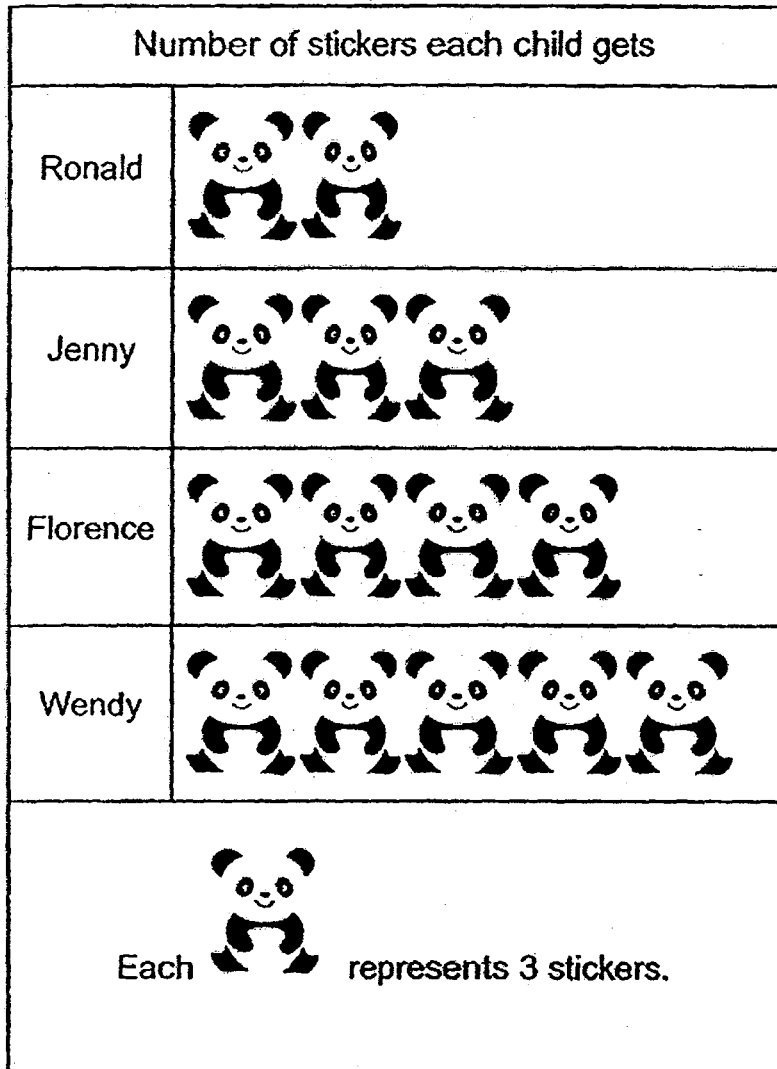

How many stickers does Florence get?

- (1) 14
- (2) 12
- (3) 9
- (4) 4

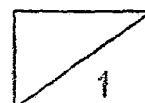

7. I am an odd number.

I am greater than 72 but smaller than 90.

What number am I?

(1) 74

(2) 83

(3) 86

(4) 91

8. Arrange the following numbers from the smallest to the greatest:

53, 37, 42, 35

(1) 53, 42, 37, 35

(2) 53, 37, 35, 42

(3) 35, 37, 42, 53

(4) 35, 42, 37, 53

9. What is the missing number in the model shown below?

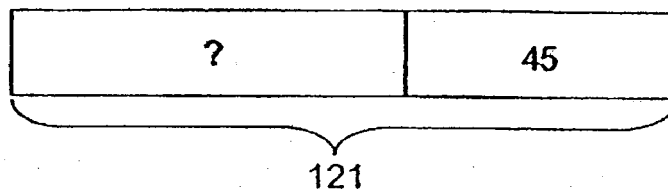

(1) 65

(2) 76

(3) 124

(4) 166

10. Mrs Raju packs 27 oranges equally into 3 bags.
How many oranges are there in each bag?

- (1) 9
- (2) 8
- (3) 7
- (4) 6

11. What is the amount of money shown below?

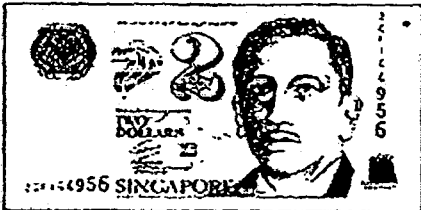
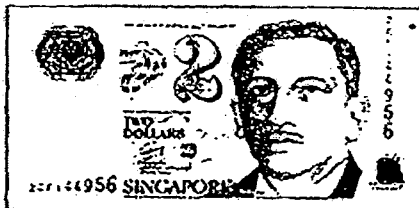
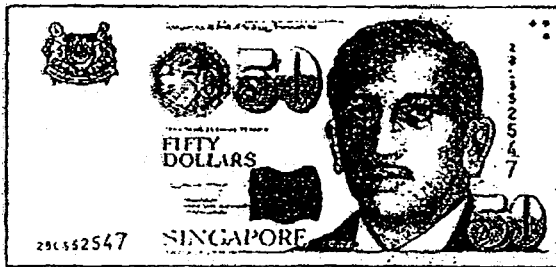

- (1) \$53.35
- (2) \$53.45
- (3) \$56.35
- (4) \$56.45

12. What is the length of a crayon?

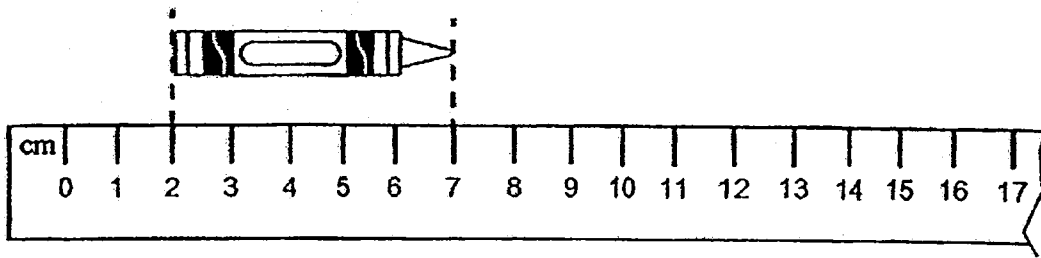

- (1) 5 cm
- (2) 2 cm
- (3) 9 cm
- (4) 11 cm

13. $1 - \frac{5}{12} = \underline{\hspace{2cm}}$

- (1) $\frac{4}{12}$
- (2) $\frac{5}{12}$
- (3) $\frac{7}{12}$
- (4) $\frac{8}{12}$

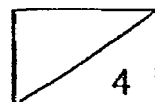

14.

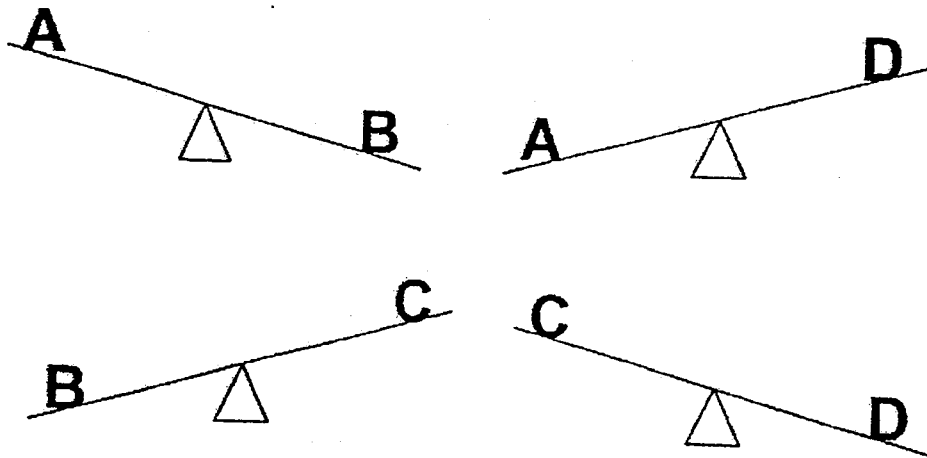

Which item is the heaviest?

- (1) A
- (2) B
- (3) C
- (4) D

Section B: Open-Ended Questions (20 marks)

Questions 15 to 20 carry 1 mark each.

Questions 21 to 27 carry 2 marks each.

15. $16 \div 2 =$ _____

Answer: _____

16. $25 \text{ ¢} = \$$ _____

Answer: \$ _____

17. What is the mass of the grapes?

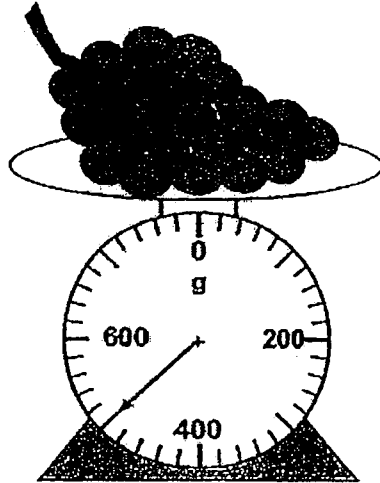

Answer: _____ g

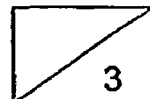

18. Name the 3-D shape shown below.



Answer: _____

19. How many triangles are there in the figure below?

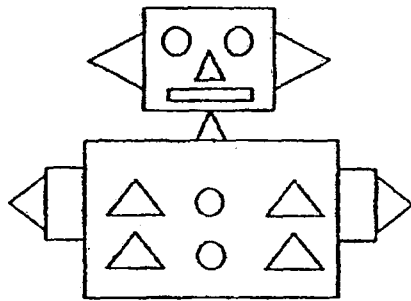

Answer: _____ triangles

20. John bought 6 balls.

May bought three times as many balls as John.

How many balls did May buy?

Answer: _____ balls

21. Look at the figure below.

Colour $\frac{5}{8}$ of the figure.

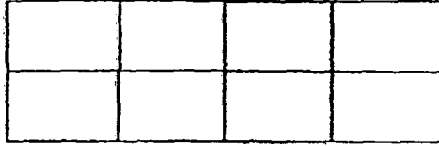

22. Bryan saved an equal amount every day.

He saved \$70 in 10 days.

How much did he save each day?

Answer. \$ _____

23. Ling has 188 beads altogether.

58 beads are green and the rest are yellow.

How many more yellow beads than green beads does she have?

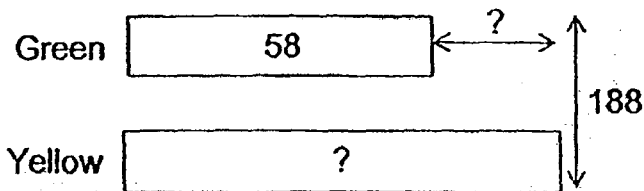

Answer: _____ more yellow beads

24. Choose three numbers below to complete the equation.



$$\square \div \square = \square$$

25. Jack cut a pizza into 6 equal pieces. He ate 3 pieces.
His sister ate 1 piece. What fraction of the pizza was left?

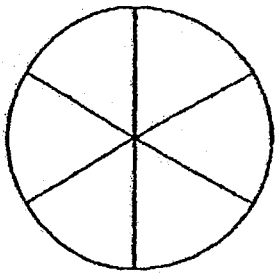

Answer: _____

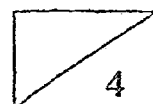

26. The picture graph below shows the number of hot dog buns Amy sold from Monday to Thursday.

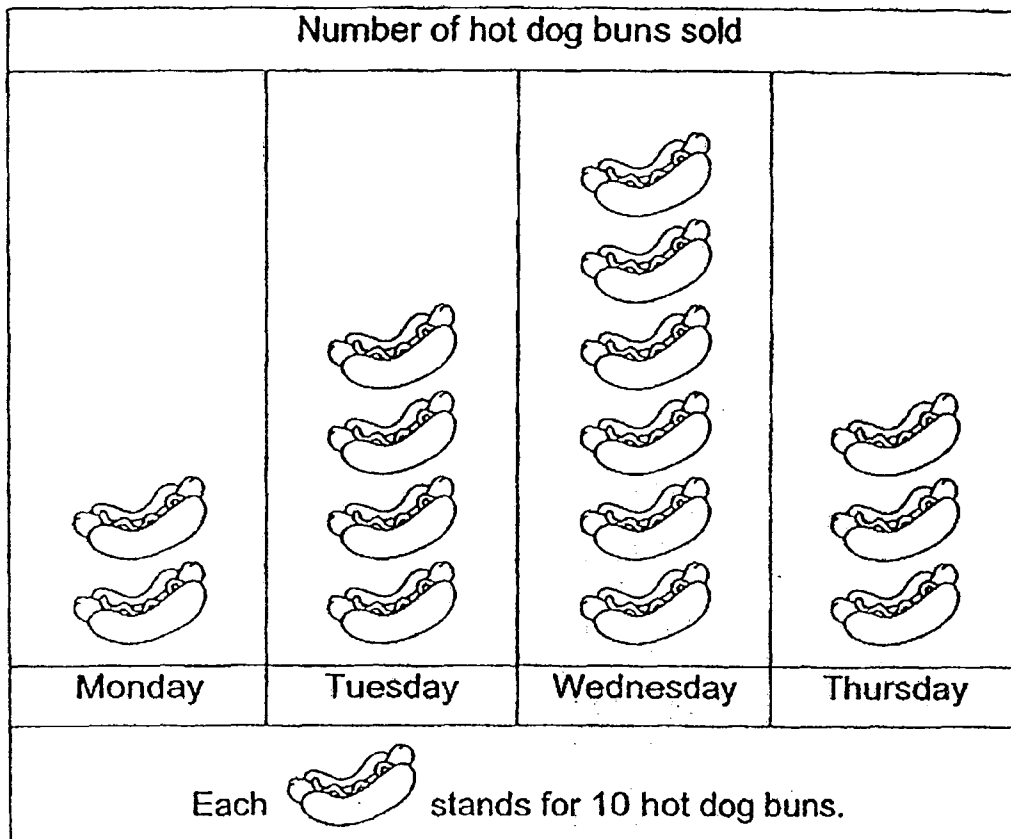

How many more hot dog buns did Amy sell on Wednesday than on Tuesday?

Answer: _____ more hot dog buns

27. Four children are queueing up.
Cindy is third in the queue.
Ali is standing between Cindy and Danny.
Brad is the last in the queue.
Who is second in the queue?

Answer: _____

Section C: Word Problem (10 marks)

Questions 28 to 29 carry 3 marks each.

Question 30 carries 4 marks.

Show your number equations clearly in the space below each question and complete the answer statements.

28. James has 208 red marbles and 124 blue marbles.

Joseph has 89 fewer marbles than James.

How many marbles does Joseph have?

Joseph has _____ marbles.

29. Tom has \$362.

He has \$115 less than Sandra.

How much money do both of them have altogether?

They have \$ _____ altogether.

30. 5 papayas and 3 mangoes cost \$60.

3 mangoes cost \$15.

a) How much do 5 papayas cost?

5 papayas cost \$ _____.

b) For every 3 mangoes bought, Charles got 1 orange free.

Charles got 2 oranges free.

How many mangoes did he buy?

Charles bought _____ mangoes.



Remember to check your work! Every mark counts.

--End of Paper --

EXAM PAPER 2017(P2)

SCHOOL : MAHA BODHI

SUBJECT : MATHEMATICS

TERM : SA2

Q1	Q2	Q3	Q4	Q5	Q6	Q7	Q8	Q9	Q10
4	3	3	1	1	2	2	3	2	1
Q11	Q12	Q13	Q14						
4	1	3	2						

15)8

16)\$0.25

17)500 g

18)cylinder

19)10

20)18

21)

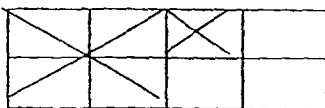

22) $70 \div 7 = \$10$

23) $188 - 58 = 130$

$130 - 58 = 72$

72 more yellow beads.

24) $28 \div 7 = 4$

25) $2/6$

26)20

27)Ali

28) $208 + 124 = 332$

$$332 - 89 = 243$$

Joseph has 243 marbles.

29) $362 + 115 = 477$

$$477 + 362 = 839$$

They have \$839 altogether.

30)a) $60 - 15 = 45$

5 papayas cost \$45

b) $3 + 3 = 6$

Charles bought 6 mangoes.



**MARIS STELLA HIGH SCHOOL (PRIMARY)
SEMESTRAL ASSESSMENT 2
PRIMARY 2 MATHEMATICS
27 OCTOBER 2017**

BOOKLET A

20 questions

20 marks

Total time for Booklets A and B: 1 h 30 min

NAME : _____ ()

CLASS : PRIMARY 2 _____

DO NOT OPEN THIS BOOKLET UNTIL YOU ARE TOLD TO DO SO.

FOLLOW ALL INSTRUCTIONS CAREFULLY.

ANSWER ALL QUESTIONS.

Section A: 20 marks (20 x 1 marks)

Choose the correct answer for each question and write its number in the bracket provided.

1. In 639, the value of the digit in the tens place is _____.

- (1) 3 ones
- (2) 30 ones
- (3) 30 tens
- (4) 30 hundreds

()

2. The odd number that comes before 367 is _____.

- (1) 365
- (2) 366
- (3) 368
- (4) 369

()

3. $258 + \underline{\hspace{2cm}} = 732$.

- (1) 474
- (2) 526
- (3) 980
- (4) 990

()

4. The mass of a pet cat is _____.

- (1) 4 g
- (2) 40 g
- (3) 4 kg
- (4) 40 kg

()

5. James counted the number of fishes in the picture below.

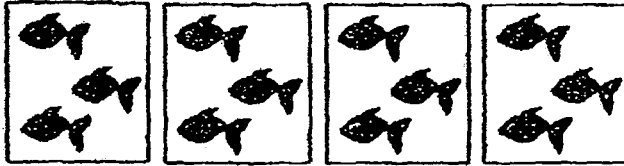

Which of the following is correct?

(1) $3 + 4$

(2) 3 fours

(3) $4 + 4 + 4$

(4) 4 groups of 3

()

6. Look at the diagram below.

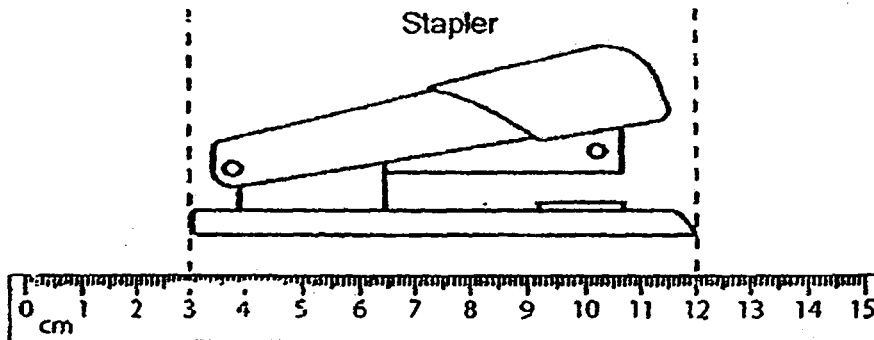

The stapler is _____ cm long.

(1) 9

(2) 10

(3) 3

(4) 12

()

7. Which of the following figures shows that $\frac{1}{4}$ of the figure is shaded?

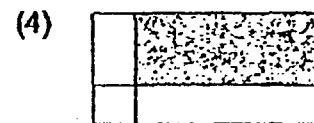
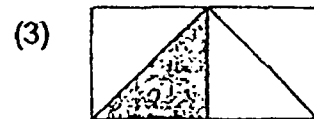
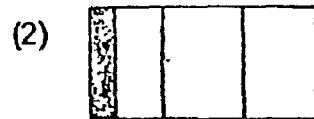
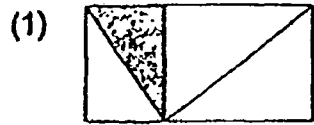

()

8. Look at the pattern below.

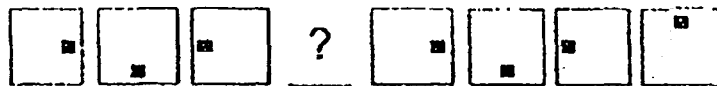

The missing shape is _____.

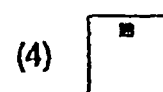
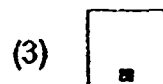

()

9. Arrange the identical beakers below from the greatest volume of liquid to the smallest volume of liquid.

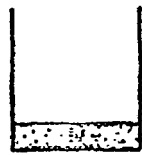

Beaker A

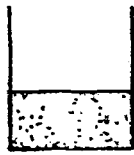

Beaker B



Beaker C

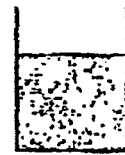

Beaker D

- (1) A, B, C, D
- (2) A, B, D, C
- (3) C, D, A, B
- (4) C, D, B, A

()

10. Mother had 32 sweets.

If she gave 4 sweets to each child, how many children were there altogether?

- (1) 6
- (2) 7
- (3) 8
- (4) 9

()

11. Ben lives on the floor just below Chris.

Denise lives on the floor just above Alvin.

Denise lives on a higher floor than Chris.

Who lives on the lowest floor?

- (1) Alvin
- (2) Ben
- (3) Chris
- (4) Denise

()

12. Paul finished his homework at the time shown below.

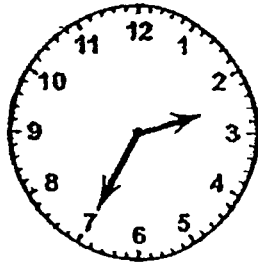

He finished his homework at _____.

- (1) 2.35
- (2) 3.35
- (3) 7.13
- (4) 7.15

()

13. Sally broke a bar of chocolate into 12 equal pieces.
Her brother ate 4 pieces.
What fraction of the chocolate did her brother eat?

- (1) $\frac{4}{8}$
- (2) $\frac{4}{12}$
- (3) $\frac{8}{12}$
- (4) $\frac{4}{16}$

()

14. What is the amount of money shown below?

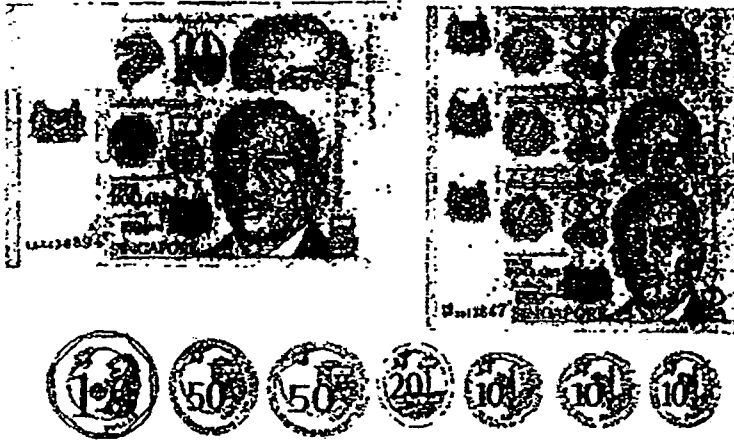

- (1) \$20.50
- (2) \$21.00
- (3) \$23.50
- (4) \$24.00

()

15. What is the value of $\frac{3}{10} + \frac{2}{10}$?

- (1) $\frac{1}{10}$
- (2) $\frac{5}{10}$
- (3) $\frac{6}{10}$
- (4) $\frac{5}{20}$

()

16. How much water must be added into Beaker A so that it has the same amount of water as Beaker B?

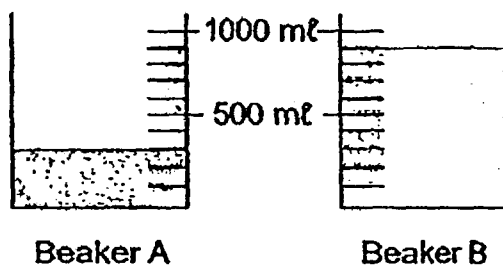

- (1) 200 mL
- (2) 300 mL
- (3) 500 mL
- (4) 600 mL

()

17. Look at the picture below carefully.

The mass of the watermelon is _____ kg.

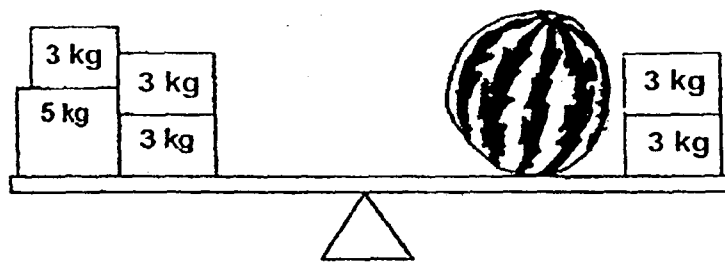

- (1) 6
- (2) 8
- (3) 11
- (4) 14

()

18. Look at the 3 sticks below.

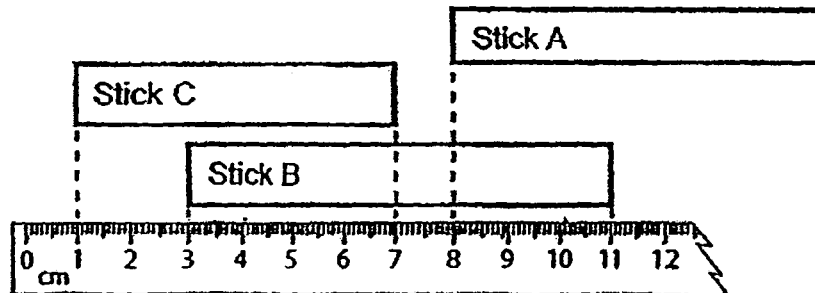

Stick A is longer than Stick C but shorter than Stick B.

What is the length of Stick A?

- (1) 5 cm
- (2) 7 cm
- (3) 13 cm
- (4) 15 cm

()

19. There are 2 flowers in each red vase.

There are 3 flowers in each blue vase.

There are 30 flowers in the vases altogether.

The number of red and blue vases is the same.

How many red vases are there?

- (1) 12
- (2) 10
- (3) 6
- (4) 5

()

20. 1 jug of water can fill up 4 glasses completely.
1 pail of water can fill up 2 jugs completely.
2 pails of water can fill up _____ glasses completely.

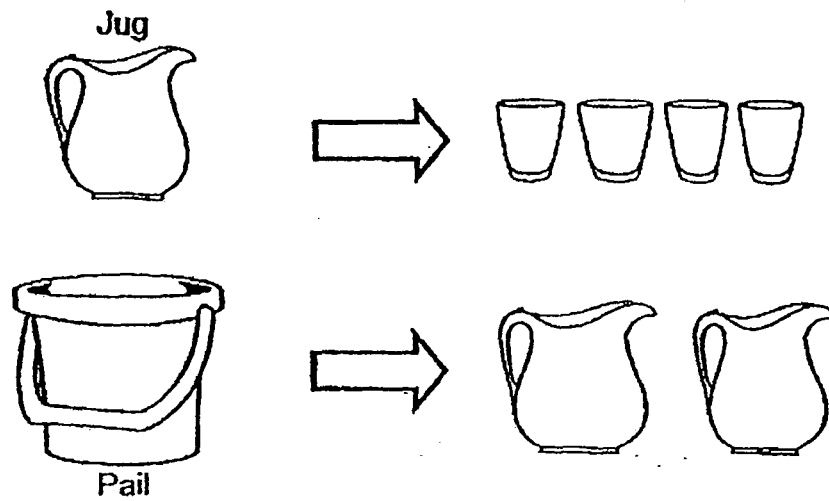

- (1) 16
- (2) 12
- (3) 8
- (4) 4

()

End of Booklet A
Go on to Booklet B



**MARIS STELLA HIGH SCHOOL (PRIMARY)
SEMESTRAL ASSESSMENT 2
PRIMARY 2 MATHEMATICS
27 OCTOBER 2017
BOOKLET B**

12 questions

30 marks

Total time for Booklets A and B: 1 h 30 min

NAME : _____ ()

CLASS : PRIMARY 2 _____

**DO NOT OPEN THIS BOOKLET UNTIL YOU ARE TOLD TO DO SO.
FOLLOW ALL INSTRUCTIONS CAREFULLY.
ANSWER ALL QUESTIONS.**

MARKS OBTAINED :

BOOKLET A: _____ / 20

BOOKLET B: _____ / 30

TOTAL : _____ / 50

Parent's Signature: _____

Section B: 18 marks (9 x 2 marks)

Fill in each blank with the correct answer.

21. I am a 3-digit even number between 130 and 140.
My 3 digits add up to 10.
What am I?

I am _____.

22. Fill in the missing numbers.

$$\begin{array}{r} 80\ \square \\ - \square 69 \\ \hline 331 \end{array}$$

23. Fill in the missing numbers.

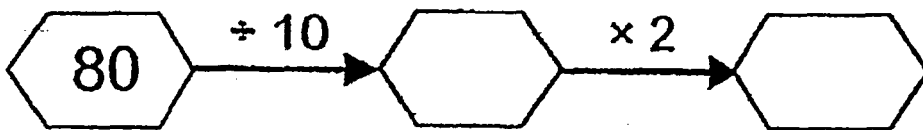

24. Shade $\frac{5}{8}$ of the figure below.

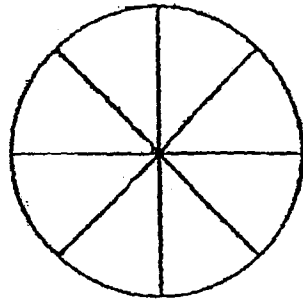

-
25. Brian walked home from school. What is the shortest distance he can take to reach home?

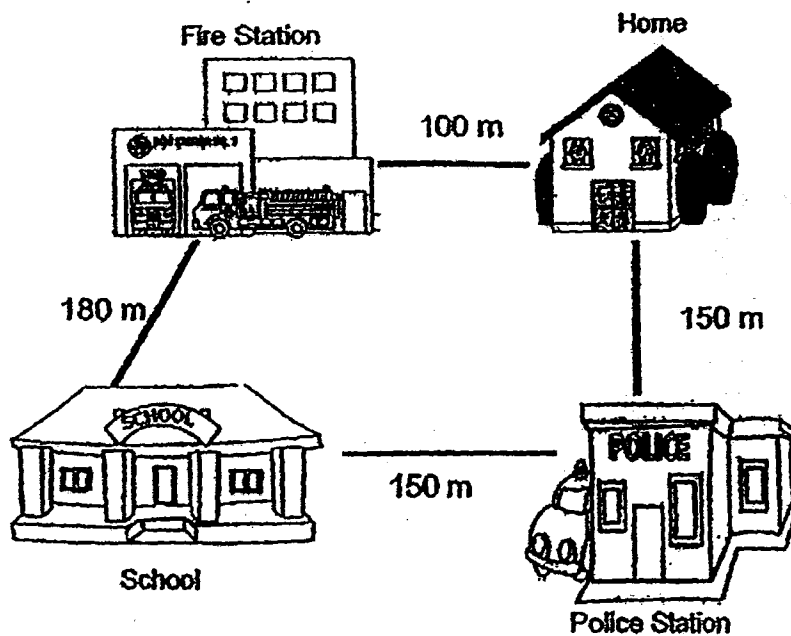

The shortest distance Brian can take is _____ m.

26. Mrs Parks sold 84 kg of honey on Saturday.
She sold 15 kg less honey on Sunday than Saturday.
How much honey did she sell altogether?

She sold _____ kg of honey altogether.

27. The figure below is made up of 1 semicircle, 1 rectangle and 1 triangle.
Draw 2 lines to show the 3 shapes.

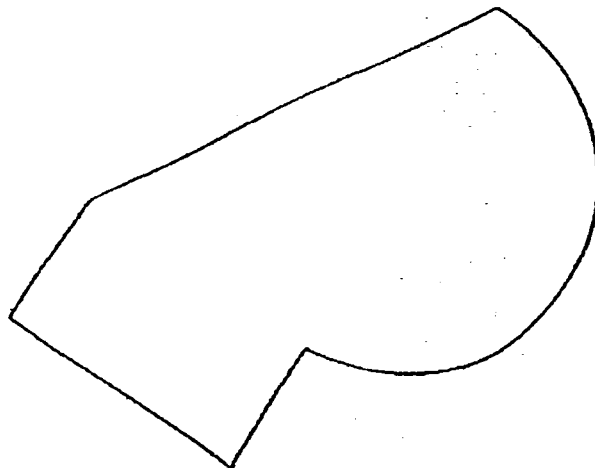

28. The picture graph below shows the number of vehicles in a carpark.

Types of vehicles	
Cars	○ ○ ○ ○ ○ ○
Buses	
Vans	○ ○ ○
Lorries	○ ○ ○ ○

(a) There are 30 cars in the carpark.
Each ○ stands for _____ vehicles.

(b) There are 40 vans and buses in the carpark altogether.
Draw the correct number of ○ in the table above to show the number of buses in the carpark.

29. Jane jogged for 1 hour at the East Coast Park.

After she stopped jogging, she took 30 minutes to walk home.

She reached home at the time shown below.

Fill in the blanks below with the correct time.

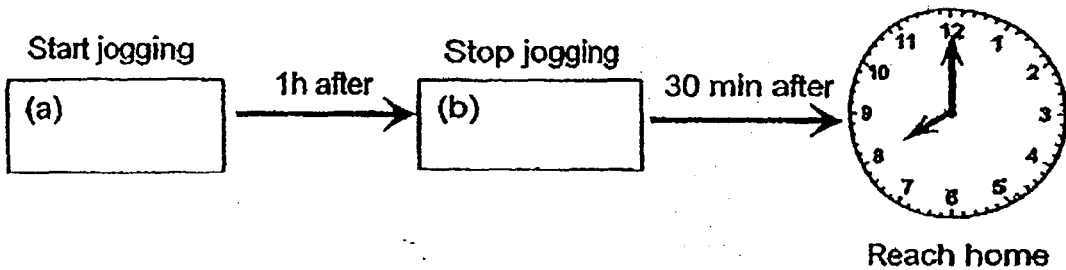

Section C: 12 marks (3 x 4 marks)

Solve the following word problems. All workings, number sentences and answer statements must be shown clearly.

30. Uncle Sam sold 238 apples.

He sold 129 more oranges than apples.

He sold 64 fewer pears than oranges.

(a) How many oranges did he sell?

He sold _____ oranges.

(b) How many pears did he sell?

He sold _____ pears.

Working

31. Look at the pictures below.

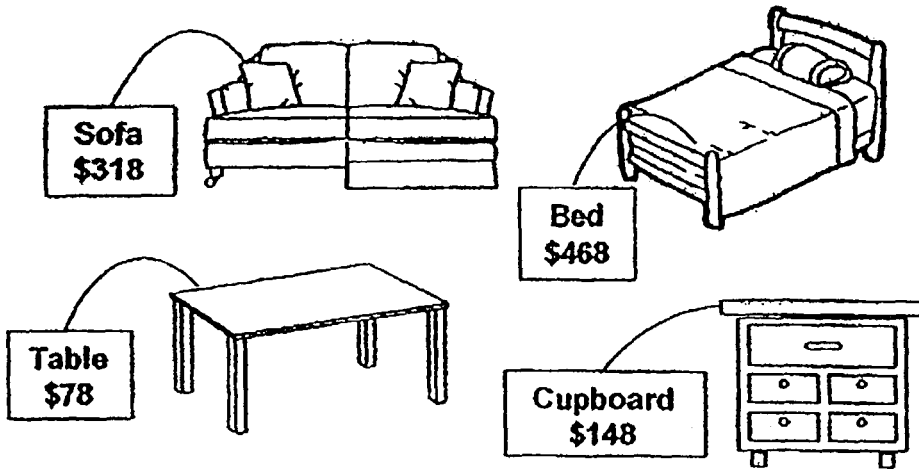

Working

(a) Peter bought the sofa and the cupboard.
Siti bought the bed. Who spent less?

_____ spent less.

(b) John has \$500. He wants to buy 2 items.
What are the different ways John can spend his money?
(Use the table to help you list the items)

Number of Ways	Item 1	Item 2

32. Baker Ben had some flour.

He used the same amount of flour each day.

By the end of Day 5, he had 590 g of flour left.

At the end of Day 6, he had 540 g of flour left.

How much flour did Baker Ben have at first?

(Hint: You may use the table below to help solve.)

Day	0	1	2	3	4	5	6
Flour left (g)						590	540

Baker Ben had _____ g of flour at first.

END OF BOOKLET B
HAVE YOU CHECKED ALL YOUR ANSWERS?

ANSWER SHEET

EXAM PAPER 2017(P2)

SCHOOL : MARIS STELLA

SUBJECT : MATHEMATICS

TERM : SA2

Q1	Q2	Q3	Q4	Q5	Q6	Q7	Q8	Q9	Q10
2	1	1	3	4	1	3	4	4	3
Q11	Q12	Q13	Q14	Q15	Q16	Q17	Q18	Q19	Q20
2	1	2	3	2	4	2	2	3	1

21)136

22)8 0 0 - 4 6 9 = 3 3 1

23)80 → 8 → 16

24)

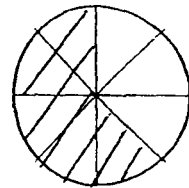

25)280 m

26)84 - 15 = 69

$$84 + 69 = 153$$

She had 153 kg of honey altogether

27)

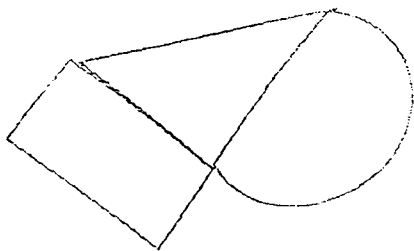

28)a)5

b) 0 0 0 0 0

29)a)6.30

b)7.30

30)a) $238 + 129 = 367$

He sold 367 oranges.

b) $367 - 64 = 303$

He sold 303 pears.

31)a)Peter

b)Number of Ways

Item 1

Item 2

1

sofa

cupboard

2

sofa

table

3

table

cupboard

32)Day -- 0 1 2 3 4 5 6

Flour-- 840 790 740 690 640 590 540

left (g)

Baker Ben had 840 g of flour at first

METHODIST GIRLS' SCHOOL
Founded in 1887



END-OF-YEAR EXAMINATION 2017
PRIMARY 2
MATHEMATICS

Total Time: 1 hour 30 minutes

INSTRUCTIONS TO CANDIDATES

Do not turn over this page until you are told to do so.
Follow all instructions carefully.
Answer all questions.
Write your answers in this booklet.

Name: _____ ()

Class: Primary 2. _____

Date: 27 October 2017

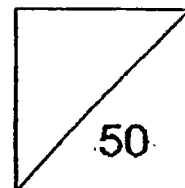

This booklet consists of 13 printed pages including this page.

Section A (10 x 1m)

Choose the correct answer for each question and write 1, 2, 3 or 4 in the brackets provided.

1. $275 + 725 =$ _____.

- (1) 550
- (2) 900
- (3) 990
- (4) 1000

()

2. 4 hundreds and 30 ones is _____.

- (1) 34
- (2) 304
- (3) 403
- (4) 430

()

3. Vivian has 10 dolls. Her sister has twice as many dolls as Vivian. How many dolls does her sister have?

- (1) 20
- (2) 10
- (3) 8
- (4) 5

()

4. 4×3 is the same as _____.

(1) $3 \times 3 \times 3 \times 3$

(2) $4 \times 4 \times 4$

(3) $3 + 3 + 3$

(4) $4 + 4 + 4$

()

5. $\frac{3}{11}$ and _____ make 1 whole.

(1) $\frac{7}{11}$

(2) $\frac{8}{11}$

(3) $\frac{9}{11}$

(4) $\frac{10}{11}$

()

6. What is 105 cents in dollars and cents?

(1) \$1.05

(2) \$1.50

(3) \$10.05

(4) \$10.50

()

7.

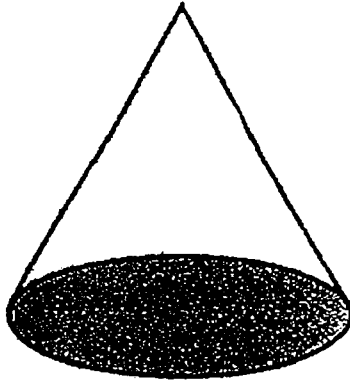

How many flat and curved surfaces are there in the solid?

- (1) 1 flat surface and 1 curved surface
- (2) 1 flat surface and 2 curved surfaces
- (3) 2 flat surfaces and 1 curved surface
- (4) 2 flat surfaces and 2 curved surfaces

()

8. Which one of the following figures has both straight lines and curves?

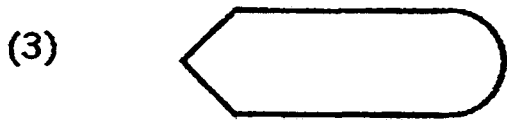
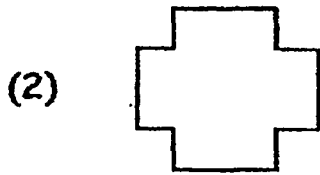

()

Study the graph below and answer Question 9 and 10.
 The picture graph shows the favourite toys of Primary 2A pupils.

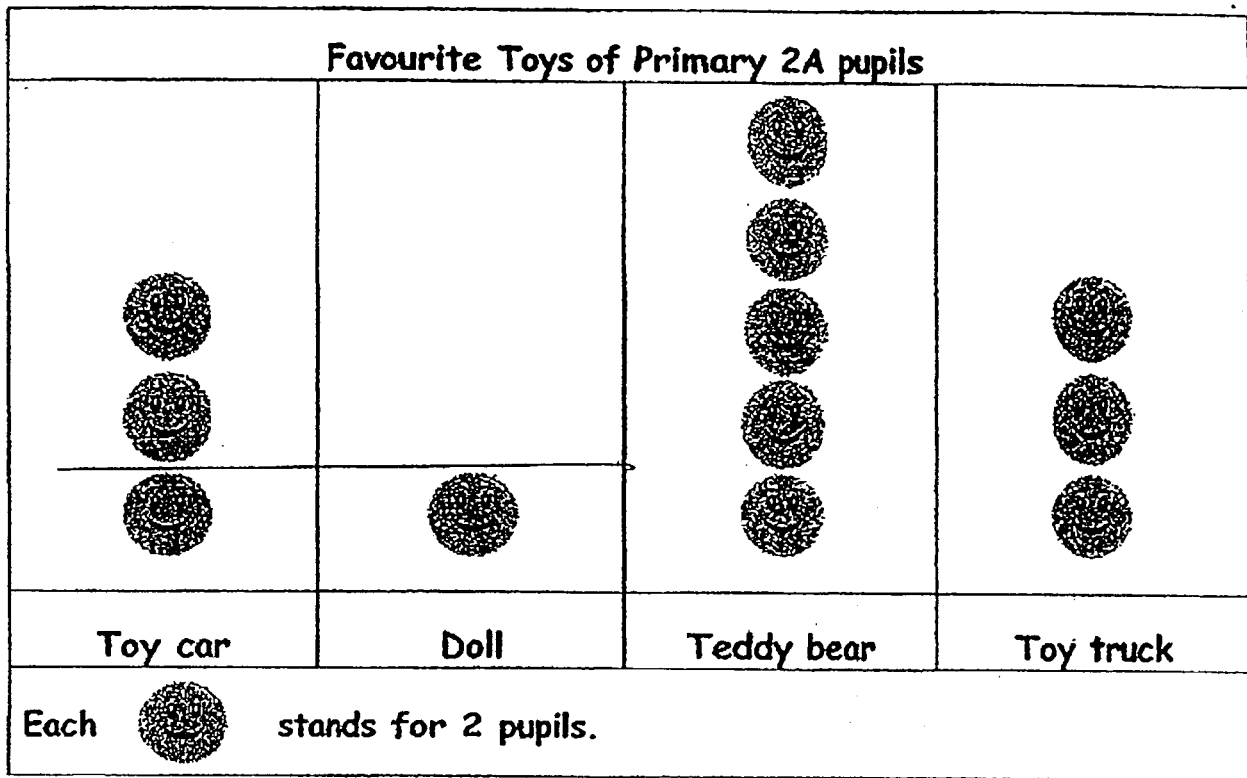

9. There are _____ fewer pupils who prefer dolls to toy cars.

(1) 16
 (2) 2
 (3) 8
 (4) 4

()

10. There are _____ pupils in Primary 2A altogether.

(1) 24
 (2) 12
 (3) 8
 (4) 4

()

Section B (5 x 1m)

Read the questions carefully. Write your answer in the space provided.

11. Write 594 in words.

Ans: _____

12. Sufen made 5 identical necklaces.
She used 8 beads for each necklace.
How many beads did she use altogether?

Ans: _____

13. Find the missing number in the box below.

$$\boxed{?} + 544 = 999$$

Ans: _____

14. Find the missing number in the box below.

$$803 - \boxed{?} = 406$$

Ans: _____

15. What is the number in the box below?

$$3 \times \boxed{?} = 27$$

Ans: _____

Section C (10 x 2m)

Read the questions carefully. Write your answer in the space provided.

16. Write 4 hundreds, 52 tens and 8 ones as a number.

Ans: _____

17. List all the even numbers from 25 to 33.

Ans: _____

18. A sheet has 10 stickers.
Caili needs 70 stickers.
How many sheets of stickers must she buy?

Ans: _____

19. What does  stand for?

$$\begin{array}{r} 4 \quad \star \quad 7 \\ - \quad \star \quad 7 \quad 9 \\ \hline \quad \quad 5 \quad 8 \\ \hline \end{array}$$

Ans: _____

20. Two boxes, A and B, contain some cakes.

Box A has 8 cakes.

Box B has 5 times as many pieces of cakes as Box A.

How many pieces of cakes are there in the two boxes altogether?

Ans: _____

21. Use the digits below to form the largest 3-digit odd number.

You are to use the digit once only.

2

6

3

Ans: _____

22. Arrange the following fractions from the greatest to smallest.

$$\frac{5}{12} \cdot \frac{5}{7} \cdot \frac{5}{10}$$

Ans: _____ , _____ , _____
(Greatest)

23. What fraction of the figure is shaded?

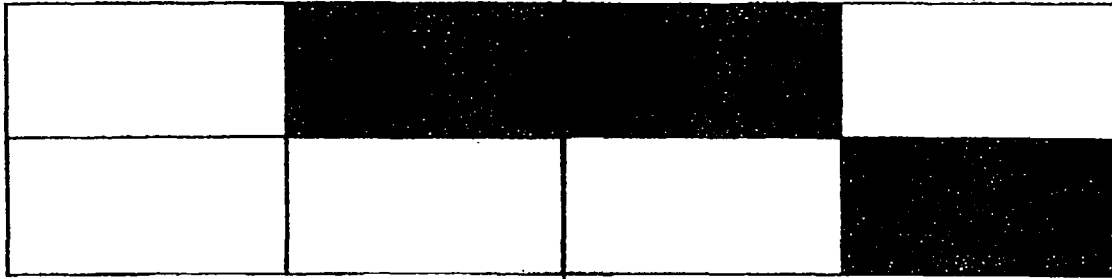

Ans: _____

24. Maria went to the market at 10.00 a.m.
She spent 1 hour at the market.
She took half an hour to reach home.
(a) What time did she leave the market?
(b) What time did she reach home?

Ans: (a) _____ a.m.

(b) _____ a.m.

25. Mrs Raja gives \$24 to her children.
Each of them receives \$6.
How many children does she have?

Ans: _____

Section D (5 x 3m)

Do these word problems. Show your working clearly.

26. A bag containing some balls weighs 11 kg.
The bag weighs 3 kg and each identical ball weighs 2 kg.
How many balls are there in the bag?

There are _____ balls in each bag.

27. Tank A has 47ℓ of water.
Tank A has 9 ℓ of water more than Tank B.
What is the total volume of water in both tanks?

The total volume of water in both tanks is _____ ℓ.

28. Sally had 145 game cards.
She gave 25 game cards to her neighbour.
She then had the same number of game cards as Adam.
How many game cards did Sally and Adam have altogether in the end?

They had _____ cards altogether.

29. A piece of ribbon was cut into 3 pieces.
The first piece is 156 cm long.
The second piece is 50 cm shorter than the first piece.
The third piece is 28 cm longer than the second piece.
What is the length of the third piece of ribbon?

The length of the third piece of ribbon is _____ cm.

30. Sam had some money.
His mother gave him \$120 and he spent \$200.
He had \$235 left.
How much money did Sam have at first?

Sam has \$ _____ at first

End of Paper
Please check your work. 😊

ANSWER SHEET

EXAM PAPER 2017(P2)

SCHOOL : MGS

SUBJECT : MATHEMATICS

TERM : SA2

Q1	Q2	Q3	Q4	Q5	Q6	Q7	Q8	Q9	Q10
4	4	1	4	2	1	1	3	4	1

11) Five hundred and ninety – four 12) $8 \times 5 = 40$

13) $999 - 544 - 455$ 14) $803 - 406 = 397$ 15) $27 \div 3 = 9$

16) $400 + 520 = 920$ 17) 26 , 28 , 30 , 32 18) $70 \div 10 = 7$

$$920 + 8 = 928$$

19) 3 20) 48 21) 623 22) $5/7$, $5/10$, $5/12$ 23) $3/8$

24) a) 11.00 a.m. b) 11.30 a.m. 25) $24 \div 6 = 4$

26) $11 - 3 = 8$

$$8 \div 2 = 4$$

There are 4 balls in the bag.

27) $47 - 9 = 38$

$38 + 47 = 85$

The total volume of water in both tanks is 85L

28) $145 - 25 = 120$

$120 \times 2 = 240$

They had 240 cards altogether.

29) $156 - 50 = 106$

$106 + 28 = 134$

The length of the third piece of ribbon is 134 cm.

30) $235 + 200 = 435$

$435 - 120 = 315$

Sam has \$315 at first.



NANYANG PRIMARY SCHOOL

**SECOND SEMESTRAL EXAMINATION
2017**

PRIMARY 2

MATHEMATICS

DURATION: 1 HOUR 30 MINUTES

Section A	/ 40
Section B	/ 40
Section C	/ 20

Total:	/ 100
--------	-------

Name: _____ ()

Class: Primary 2 ()

Date: 26 October 2017

Parent's Signature: _____

Any query on marks awarded should be raised by **8 November 2017**.
We seek your understanding in this matter as any delay in the
confirmation of marks will lead to delays in the generation of results.

Parent's Signature: _____

**DO NOT OPEN THIS BOOKLET UNTIL YOU ARE TOLD TO DO SO.
FOLLOW ALL INSTRUCTIONS CAREFULLY.
ANSWER ALL QUESTIONS.**

Section A

Questions 1 to 20 carry 2 marks each.

For each question, four options are given.

One of them is the correct answer.

Choose the correct answer and write its number (1, 2, 3 or 4) in the brackets () provided. (Total: 40 marks)

1. Look at the number pattern below.
The frog jumps from one leaf to the next leaf and counts in tens.

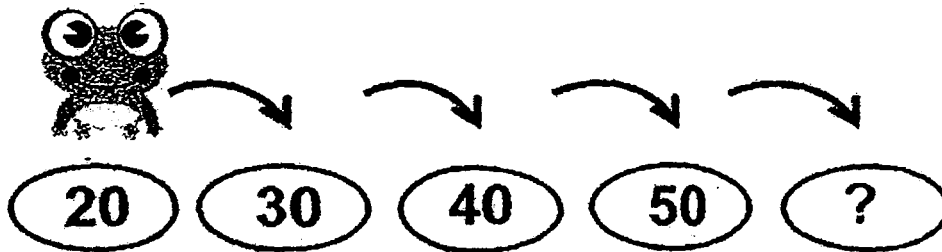

What is the number on the last leaf?

- | | |
|--------|--------|
| (1) 6 | (2) 40 |
| (3) 51 | (4) 60 |
2. What is the value of $600 + 40 + 5$?
- | | |
|---------|---------|
| (1) 609 | (2) 645 |
| (3) 654 | (4) 690 |
3. What is 8 groups of 4?
- | | |
|--------|--------|
| (1) 32 | (2) 24 |
| (3) 12 | (4) 4 |

4. Look at the picture below.

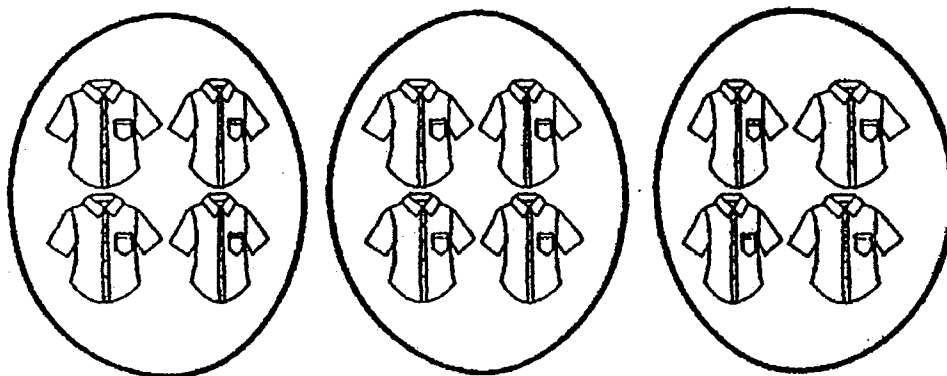

Which one of the following equations show how the shirts are grouped?

(1) 6×2
(3) $12 \div 2$

(2) $12 \div 3$
(4) $3 + 4$

5. Look at the figure below.

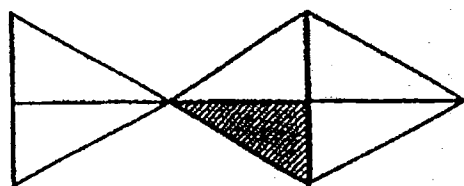

What fraction of the figure is shaded?

(1) $\frac{1}{4}$

(2) $\frac{1}{5}$

(3) $\frac{1}{6}$

(4) $\frac{5}{6}$

6. $\frac{4}{5} - \frac{2}{5} = \boxed{?}$

What is the missing fraction in the box?

(1) $\frac{1}{5}$

(2) $\frac{2}{5}$

(3) $\frac{2}{10}$

(4) $\frac{6}{10}$

7. Look at the diagram below.

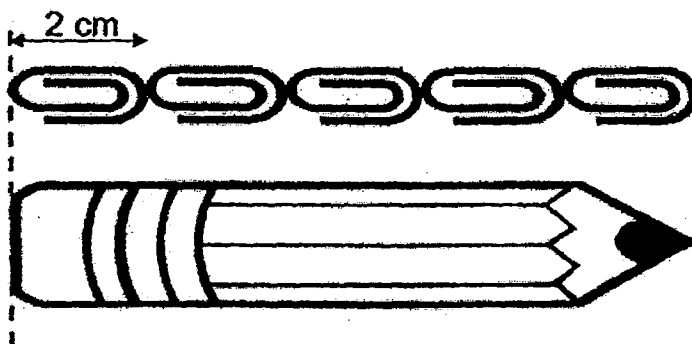

What is the length of the pencil?

- (1) 5 cm
(3) 10 cm

- (2) 8 cm
(4) 12 cm

8. Look at the diagram below.

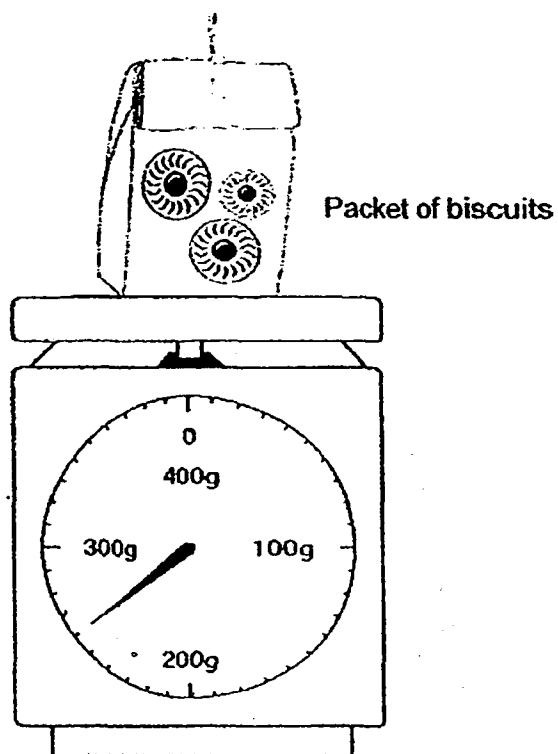

What is the mass of the packet of biscuits?

- (1) 60 g
- (2) 206 g
- (3) 260 g
- (4) 360 g

9. Ali saved the following amount of money for his favourite storybook.

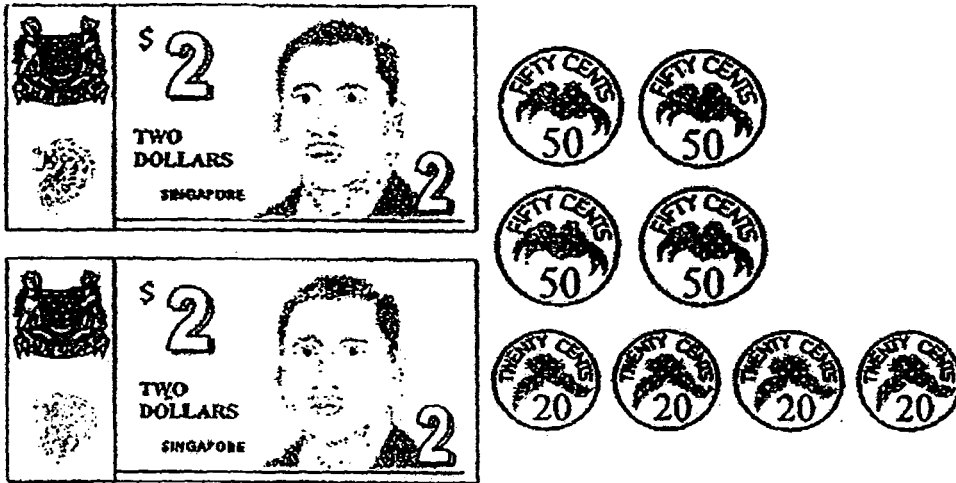

How much money did he save in total?

- (1) \$6.80 (2) \$6.40
 (3) \$4.80 (4) \$4.00
10. Look at the picture below.

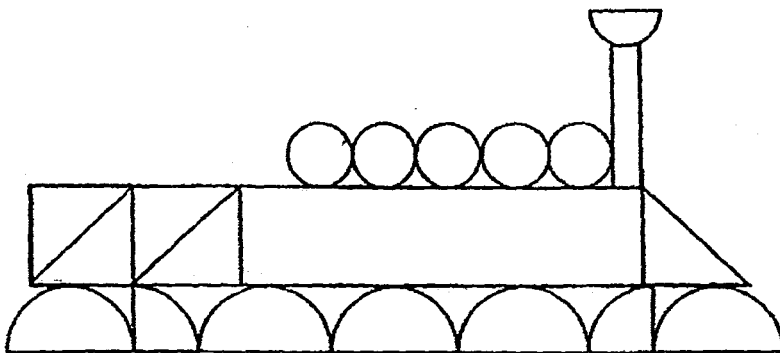

How many semicircles can you find?

- (1) 13 (2) 8
 (3) 6 (4) 5

11. The picture graph below shows the favourite type of fruit of a group of children.

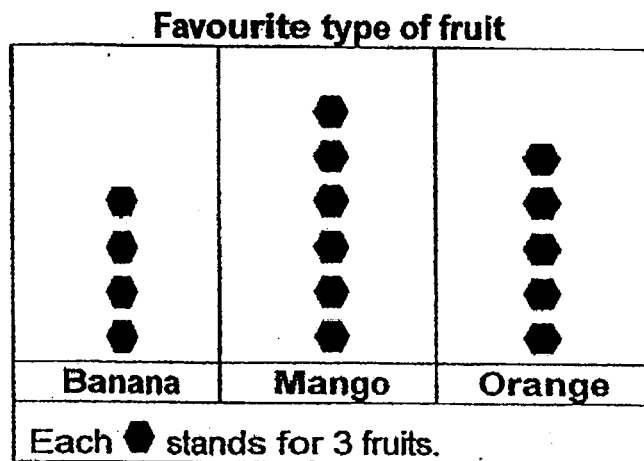

Which one of the following statements is wrong?

- (1) Most of the children like mango.
 - (2) There are 3 more children who like orange than banana.
 - (3) There are 5 children who like orange.
 - (4) The least favourite type of fruit is banana.
12. Mrs Tan sold 187 cakes on Saturday.
She sold 129 more cakes on Sunday than on Saturday.
How many cakes did she sell on Sunday?

- (1) 206
- (2) 216
- (3) 306
- (4) 316

13. John had \$300.
He bought a bag for \$108.
How much money had he left?

- (1) \$102 (2) \$192
(3) \$202 (4) \$208

14. The picture below shows the length of one ribbon.

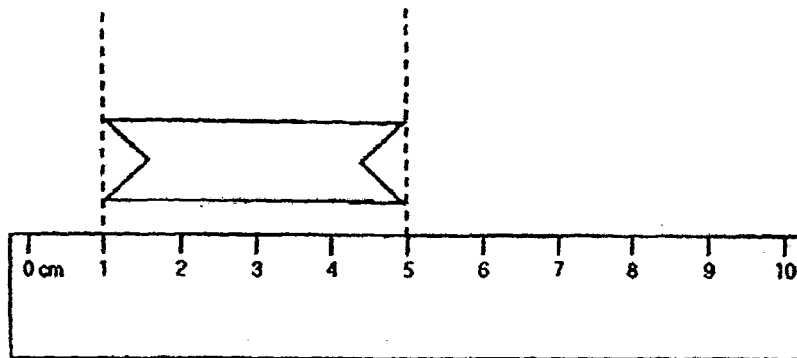

What is the total length of 4 such ribbons?

- (1) 20 cm (2) 16 cm
(3) 5 cm (4) 4 cm
15. Bob hung 20 shirts.
He hung 4 shirts on each pole.
How many poles did he use to hang all the shirts?

- (1) 24 (2) 16
(3) 5 (4) 4

16. James started his swimming lesson at half past 4 in the afternoon.
His swimming lesson lasted 60 min.

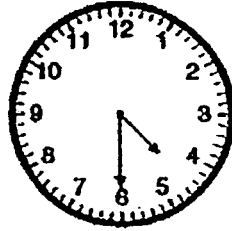

Start of his swimming lesson

What time did his swimming lesson end?

- (1) 3.30 a.m. (2) 3.30 p.m.
(3) 5.30 a.m. (4) 5.30 p.m.
17. The diagram below shows the amount of money Reuben has.

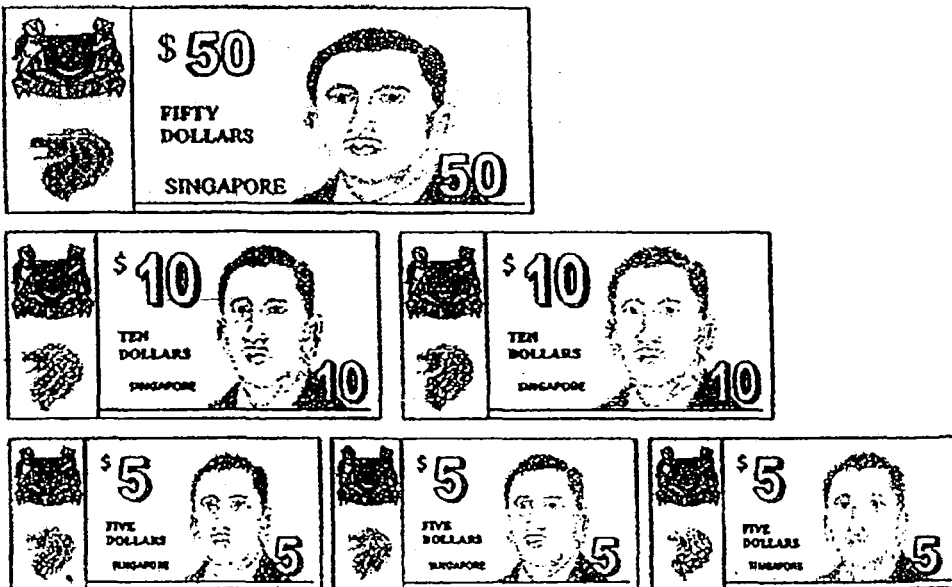

He wants to buy a toy plane that costs \$140.
How much more money does he need?

- (1) \$55 (2) \$65
(3) \$75 (4) \$85

18. Nate had some money at first.
He paid \$79 for a badminton racket and \$45 for a soccer ball.
He had \$301 left in the end.
How much money did he have at first?

- (1) \$124 (2) \$177
(3) \$415 (4) \$425

19. Kavitha used a total of 10 red ropes and blue ropes.
Each red rope was 2 m long.
Each blue rope was 3 m long.
The total length of ropes she used was 26 m.
How many blue ropes did she use?

- (1) 5 (2) 6
(3) 3 (4) 4

20. The mass of a box with apples was 8 kg.
The mass of the empty box was 2 kg.
Johan bought 4 such boxes of apples.
What was the total mass of the apples that Johan bought?

- (1) 6 kg (2) 16 kg
(3) 24 kg (4) 30 kg

Section B

Questions 21 to 40 carry 2 marks each.

Show your working clearly in the space provided for each question and write your answer in the blank provided. (Total: 40 marks)

21. Arrange the numbers below from the smallest to the greatest.

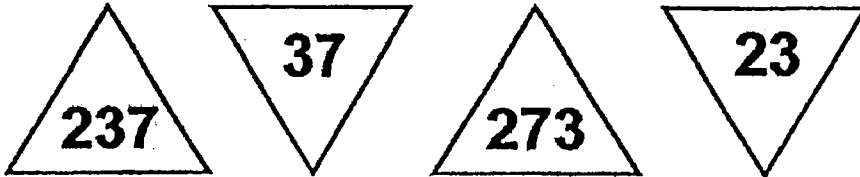

_____ , _____ , _____ , _____
smallest

22. What is the value of $450 - 243$?

Answer : _____

23. Look at the picture below.

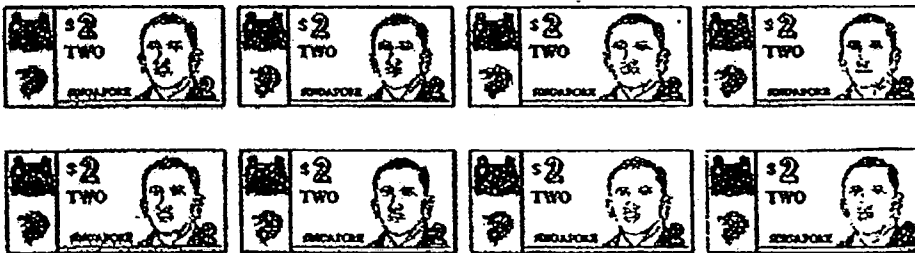

How much money is there in total?

Answer : \$ _____

24. Arrange the fractions below from the greatest to the smallest.



_____ , _____ , _____ , _____
greatest

25. What is the sum of $\frac{3}{8}$ and $\frac{2}{8}$?

Answer : _____

26. Look at the picture below.

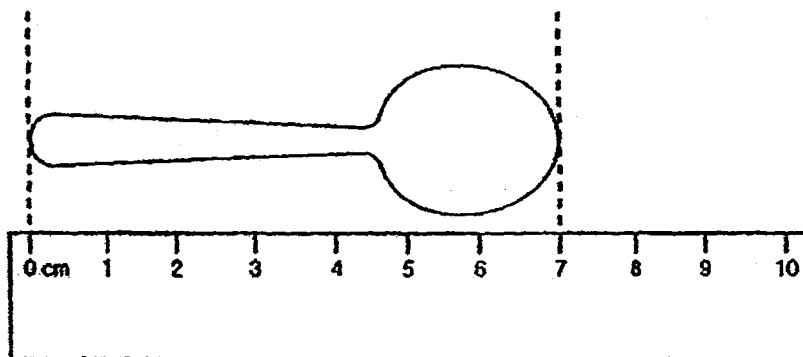

What is the length of the spoon?

Answer : _____ cm

27. Ahmad started to do his homework at 2.30 p.m.
Draw the hands on the clock face below to show the time he started to do his homework.

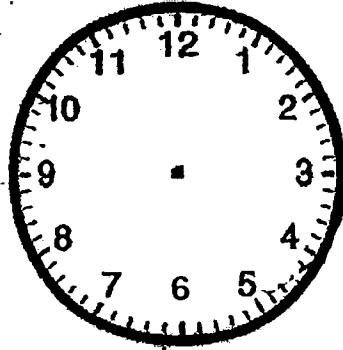

Started to do his homework

28. Write \$4.20 in cents.

Answer : _____¢

29. Amelia bought 220 roses.
Bala bought 320 roses.
Charlene bought 190 roses.
How many roses did they buy in total?

Answer : _____

30. Look at the 3-D object below.

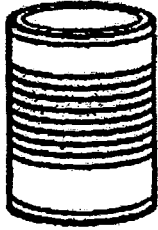

What is the shape of the 3-D object?
Circle the name of the shape shown above.

Cone / Cube / Cylinder / Cuboid

31. There are 4 number patterns as shown below.
In a number pattern, the digit in the ones place increases by 1.
Tick the correct box that shows the number pattern.

47, 57, 67, 77

57, 56, 55, 54

92, 93, 94, 95

68, 70, 72, 74

32. Xiaomin baked some cakes.
For each cake that Xiaomin baked, she used 3 eggs and 120 g of flour.
She used a total of 9 eggs.
How much flour did she use?

Answer : _____ g

33. In a basketball match, each team has 5 players.
There are 7 teams in total.
How many basketball players are there altogether?

Answer : _____

34. In the box below, 4 dots A, B, C and D are given.
Draw a straight line to join 2 of the dots that form a line with a length of 8 cm.

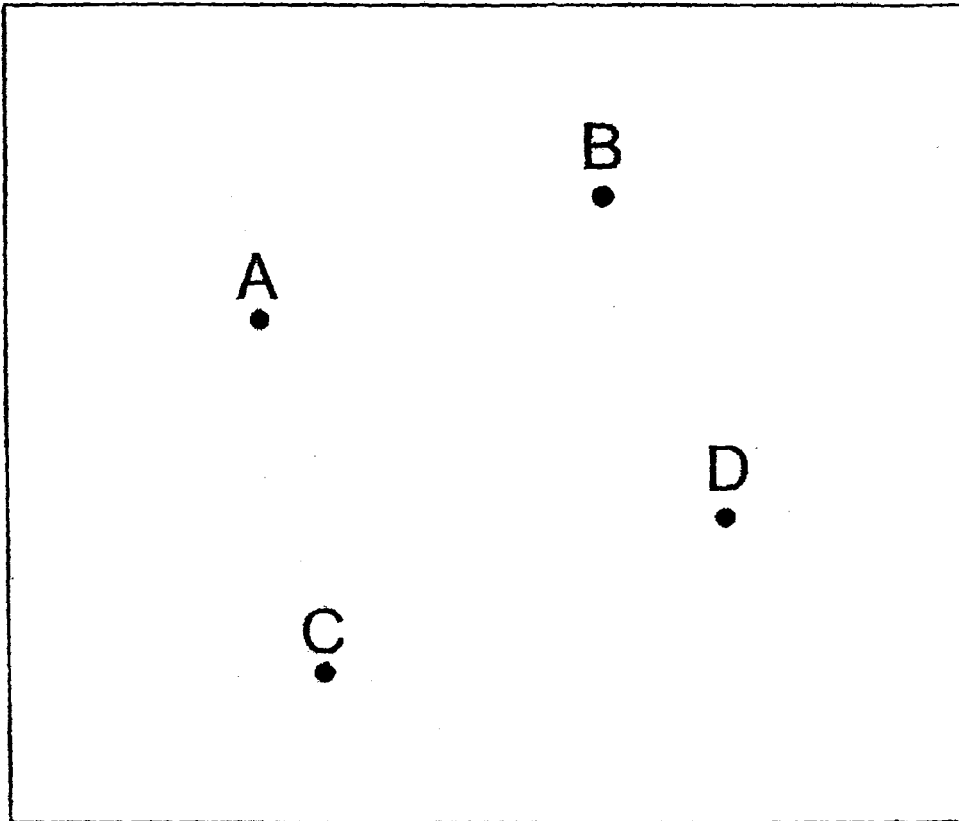

37. Look at the pattern below.

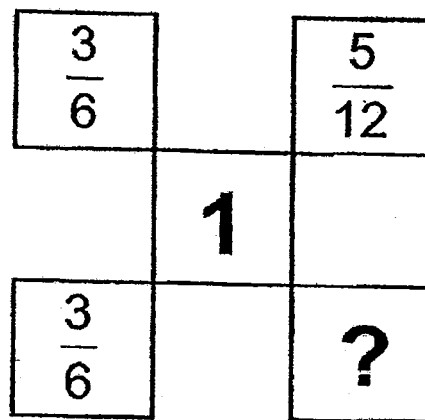
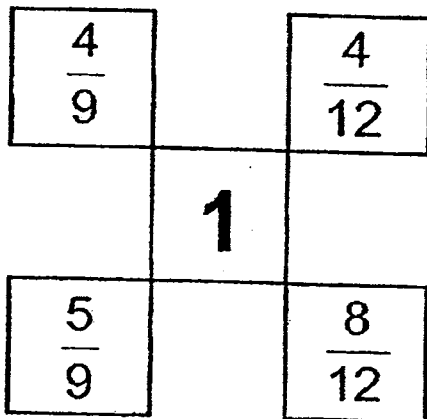
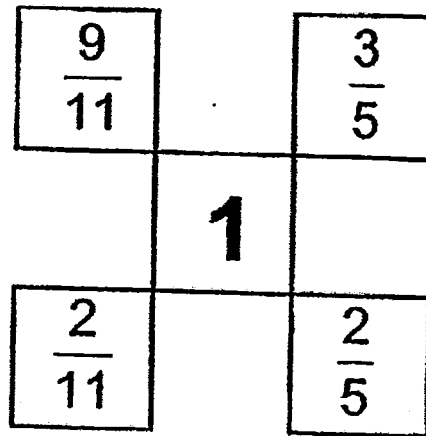
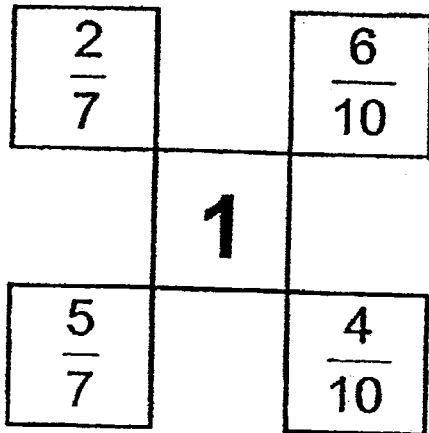

What is the missing fraction?

Answer : _____

38. Along a street, the lamp posts are placed at regular distance of 10 m apart.

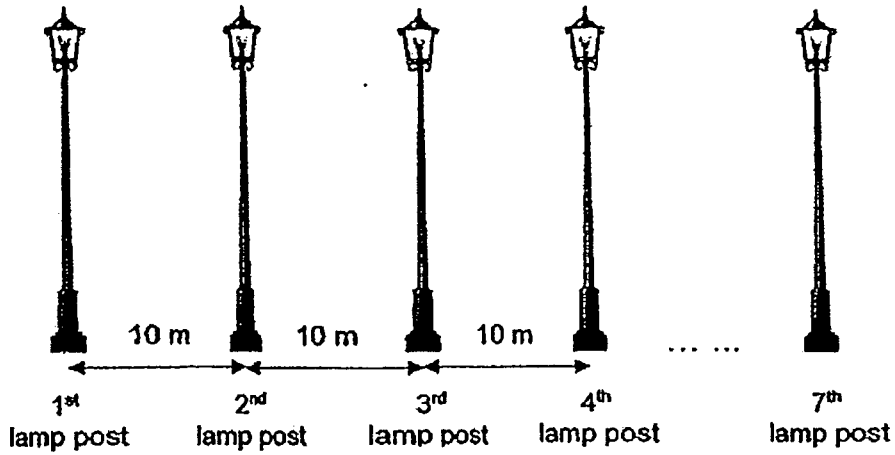

What is the distance from the first lamp post to the seventh lamp post?

Answer : _____ m

39. Carrie wants to decorate 3 cakes.
She needs 4 kg of chocolate to decorate one cake.
The mass of each packet of chocolate is 2 kg.
How many such packets of chocolate does she need?

Answer : _____

40. The picture graph below shows the number of pupils in Class 1A and Class 1B who can cycle.

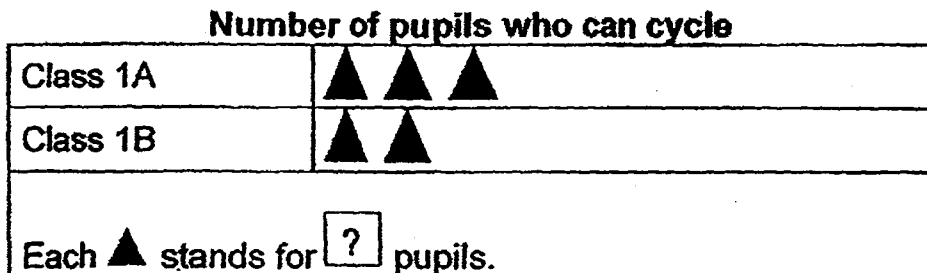

There are 35 pupils who can cycle in Class 1A and Class 1B.
How many pupils does each ▲ stand for?

Answer : _____

Section C

Questions 41 to 45 carry 4 marks each.

Do these word problems carefully.

Show your working clearly in the space provided for each question.

(Total: 20 marks)

41. Mary had 110 red balloons.
She had 27 fewer blue balloons than red balloons.

(a) How many blue balloons did she have?

She had _____ blue balloons.

- (b) She gave away 33 red balloons.
How many red balloons had she left?

She had _____ red balloons left.

42. A tricycle had 3 wheels.
Andy had 7 tricycles.

(a) How many wheels were there in total?

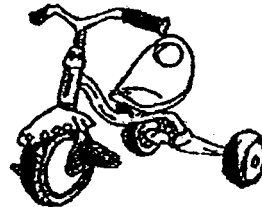

Tricycle

There were _____ wheels in total.

After selling some tricycles, Andy was left with 3 tricycles.
He removed all the wheels from the tricycles left.

(b) How many wheels did Andy remove?

Andy removed _____ wheels.

43. Fandi has \$542.
Fandi has \$150 more than Ethan.

(a) How much money does Ethan have?

Ethan has \$_____.

Wen Ting has \$10 more than Fandi.

(b) How much money must Wen Ting give Fandi so that both of them have the same amount of money in the end?

Wen Ting must give Fandi \$_____.

44. Srija took 10 days to save \$30.
She saved the same amount of money every day.

(a) How much money did Srija save a day?

Srija saved \$_____ a day.

An adult and a child can visit a museum at a total cost of \$5.
Srija likes to visit the museum with her grandfather.

(b) With the amount of money that she had saved, how many
times could Srija visit the museum with her grandfather?

Srija could visit the museum with her grandfather
_____ times.

45. I am thinking of a 2-digit number.
The number is smaller than 30 and bigger than 20.
The sum of the digits is 9.

(a) What is the 2-digit number?

The 2-digit number is _____.

I am thinking of another number.
It is a 3-digit number.
The digit in the ones place is the smallest odd number.
The digit in the tens place has a value of 30.
The digit in the hundreds places stands for 200.

(b) What is the 3-digit number?

The 3-digit number is _____.

☺ End of Paper ☺
Please Check Carefully

EXAM PAPER 2017(P2)

SCHOOL : NANYANG

SUBJECT : MATHEMATICS

TERM : SA2

Q1	Q2	Q3	Q4	Q5	Q6	Q7	Q8	Q9	Q10
4	2	1	2	3	2	3	3	1	3
Q11	Q12	Q13	Q14	Q15	Q16	Q17	Q18	Q19	Q20
3	4	2	2	3	4	1	4	2	3

21) 23, 37, 237, 273

22) 207

23) \$16

24) $\frac{5}{7}$, $\frac{4}{7}$, $\frac{2}{7}$, $\frac{1}{7}$

25) $\frac{5}{8}$

26) 7 cm

27)

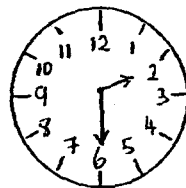

28) 420 c

29) 730

30) Cylinder

31) 92, 93, 94, 95

32) 3 eggs = 120g

9 eggs = 360g

ANS: 360g

33) $7 \times 5 = 35$

34)

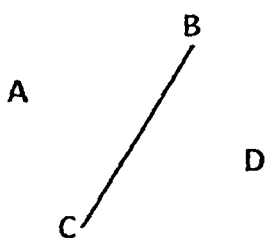

35)

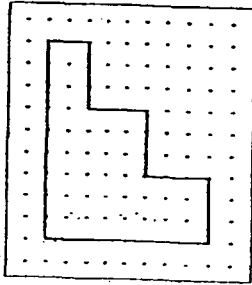

36) $25 \div 5 = 5$

37) $12/12 - 5/12 = 7/12$

38) $6 \times 10 = 60 \text{ m}$

39) $4 \div 2 = 2$

40) $35 \div 5 = 7$

$3 \times 2 = 6$

41)a) $110 - 27 = 83$

She had 83 blue balloons.

b) $110 - 33 = 77$

She had 77 red balloons left.

42)a) $7 \times 3 = 21$

There were 21 wheels in total.

b) $3 \times 3 = 9$

Andy removed 9 wheels.

43)a) $542 - 150 = 392$

Ethan has \$392

b) Wen Ting must give Fandi \$5

44)a) $30 \div 10 = 3$

Srija saved \$3 a day.

b) $30 \div 5 = 6$

45) a) $2 + 7 = 9$

The 2-digit number is 27.

b) 2 . 3 1

hundreds Tens one

The 3-digit number is 231

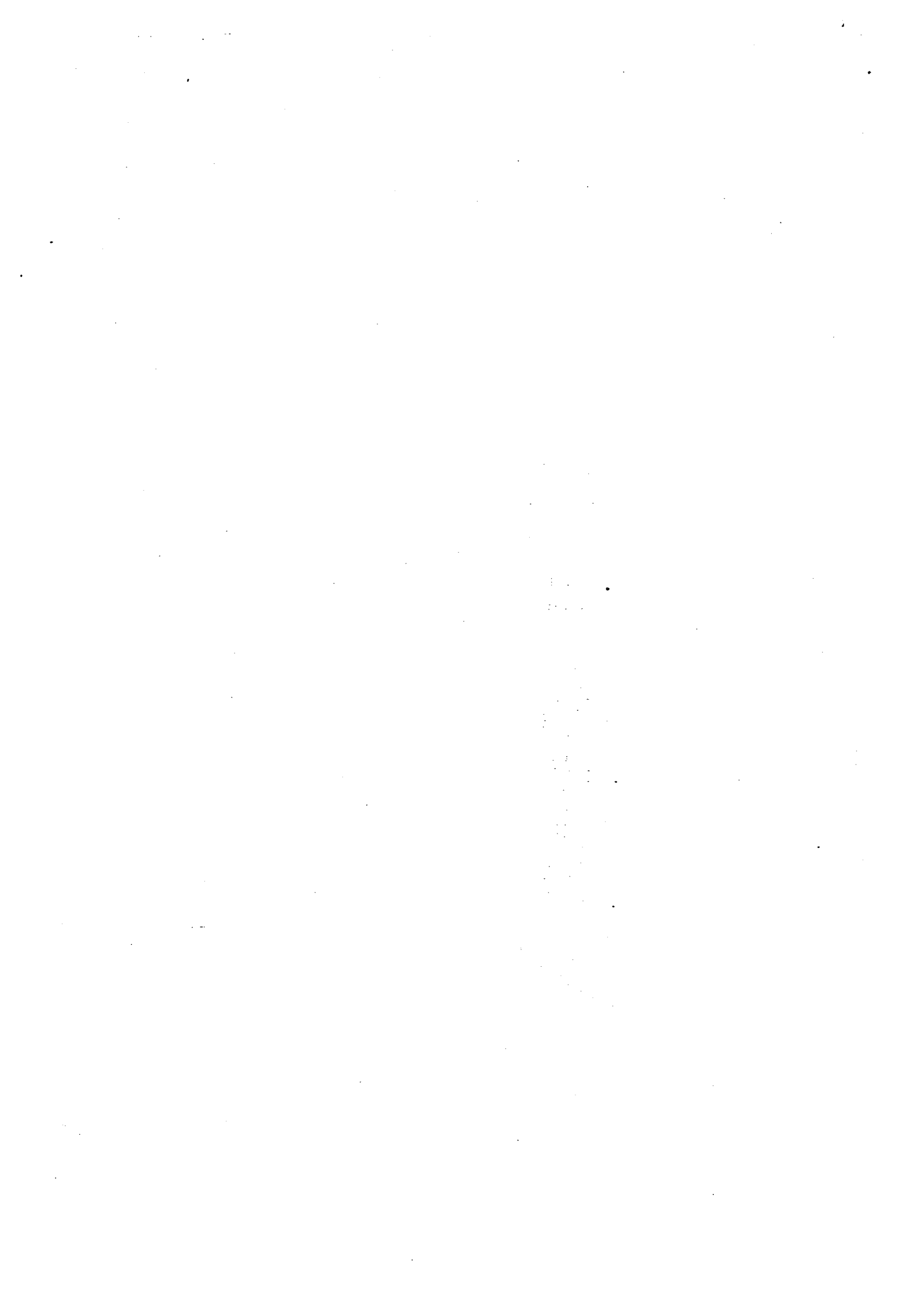



RAFFLES GIRLS' PRIMARY SCHOOL
PRIMARY TWO MATHEMATICS
SEMESTRAL ASSESSMENT 2
2017

Your score out of 50 marks	
Parent's Signature	

Name: _____ () Class: P2 _____

26 October 2017

Duration: 1h 30min

Section A: (Q1 to Q8: 1 mark each; Q9 to Q14: 2 marks each; Total: 20 marks)

Choose the correct answer and write its number (1, 2, 3 or 4) in the brackets provided.

1. What is the number shown in the place value chart?

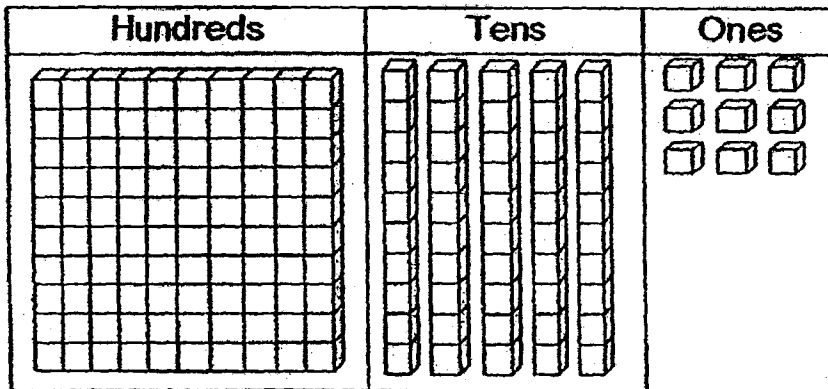

(1) 149

(3) 259

(2) 159

(4) 951

()

2. $325 + 162 =$ _____

(1) 163

(3) 487

(2) 343

(4) 597

()

3. $799 - 168 =$ _____

(1) 531

(3) 631

(2) 632

(4) 967

()

4. $9 \times 4 =$ _____

(1) 32

(3) 36

(2) 35

(4) 37

()

5. The pencil is about _____ cm long.

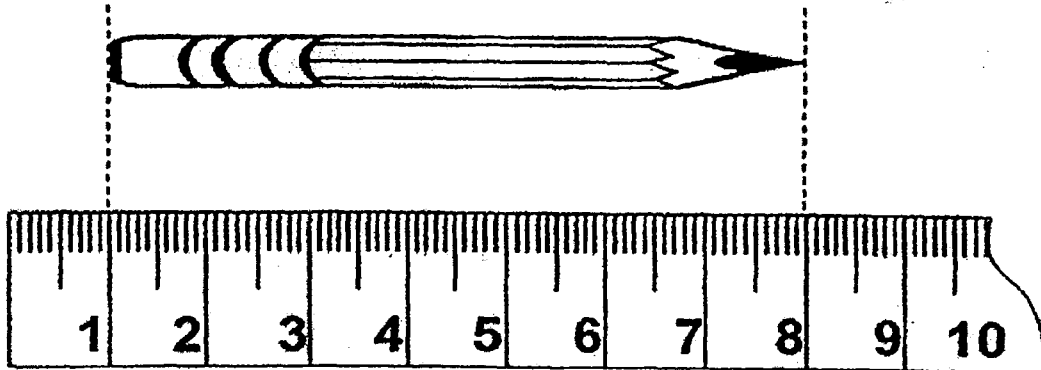

(1) 7

(3) 3

(2) 8

(4) 9

()

6. How much money does Lily have in her purse?

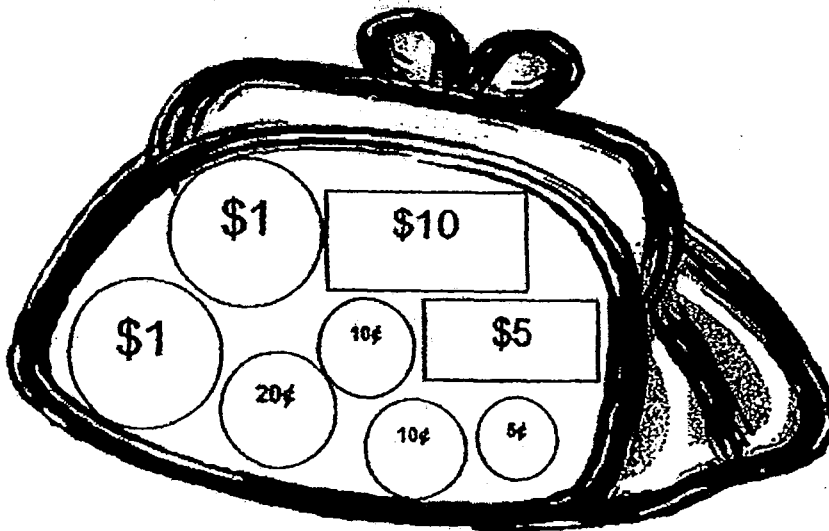

(1) \$12.40

(3) \$17.45

(2) \$17.40

(4) \$22.45

()

7. How heavy is the cabbage?

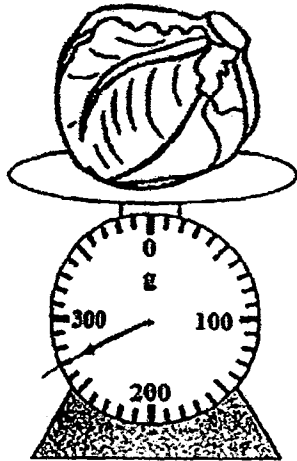

(1) 220 g

(2) 270 g

(3) 250 g

(4) 330 g

()

8. Which one of the following shows the time is 5 minutes after 10 o'clock

(1)

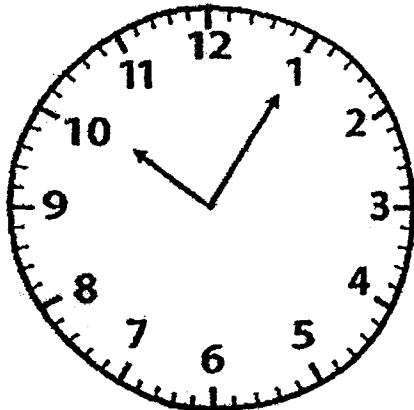

(3)

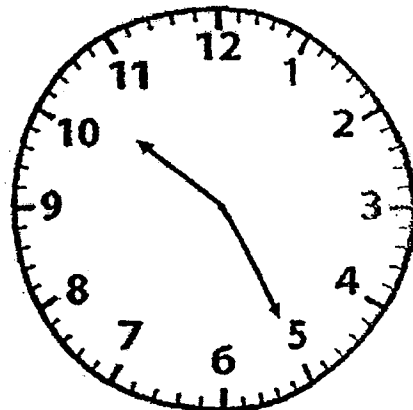

(2)

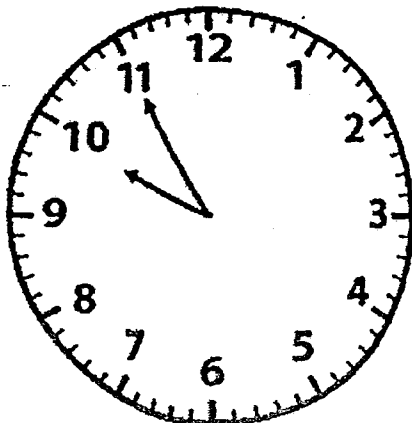

(4)

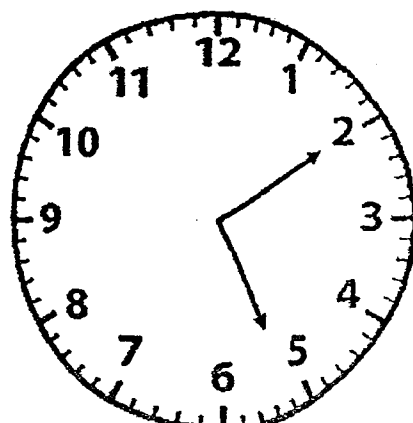

()

9. What is the value of the digit 2 in 62 tens?

(1) 200

(3) 62

(2) 2

(4) 20

()

10. How many rectangles are there in the figure below?

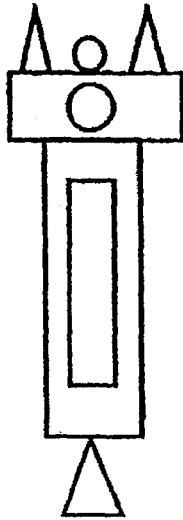

(1) 1

(3) 3

(2) 2

(4) 4

()

11. Arrange the amounts of money below in order. Begin with the greatest.

\$363.99

\$636.99

\$636.09

(1) \$363.99, \$636.09, \$636.99

(3) \$636.09, \$636.99, \$363.99

(2) \$636.99, \$363.99, \$636.09

(4) \$636.99, \$636.09, \$363.99 ()

12. Which of the following fractions are arranged in order starting with the smallest?

(1) $\frac{1}{7}$, $\frac{1}{5}$, $\frac{1}{3}$

(3) $\frac{1}{3}$, $\frac{1}{7}$, $\frac{1}{5}$

(2) $\frac{1}{3}$, $\frac{1}{5}$, $\frac{1}{7}$

(4) $\frac{1}{5}$, $\frac{1}{7}$, $\frac{1}{3}$

()

13. Mrs Tan put 45 cupcakes equally in 5 trays. How many cupcakes were there in each tray?

(1) 8

(3) 40

(2) 9

(4) 50

()

14. Arrange the four items (A, B, C and D) from the heaviest to the lightest

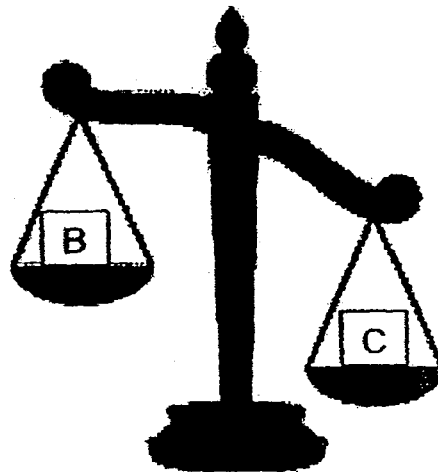
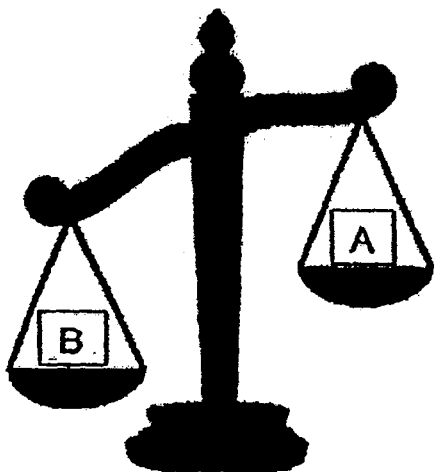
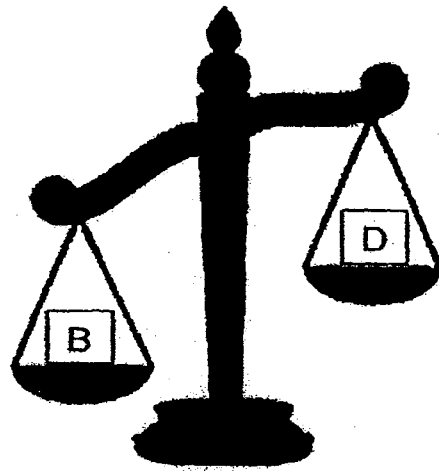
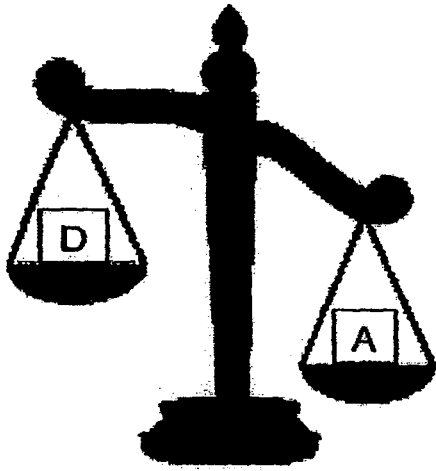

(1) A, D, B, C

(3) C, B, A, D

(2) B, A, C, D

(4) D, A, C, B

()

Section B:(Q15 to Q23: 1 mark each; Q24 to Q29: 2 marks each; Total: 21 marks)

Work out these questions carefully and write the answers in the boxes or blanks provided.

15. Write the number below in words.

843 _____

16. $8 \times 3 =$ _____

17. $28 + 4 =$ _____

18. What is the volume of juice in the jug?

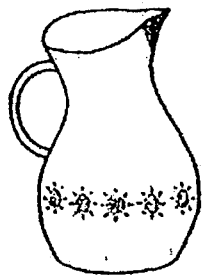

jug

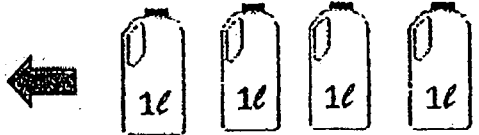

litres

19. The clock shows the time that Mary went to the library to return her books.
What time did Mary go to the library to return her books?

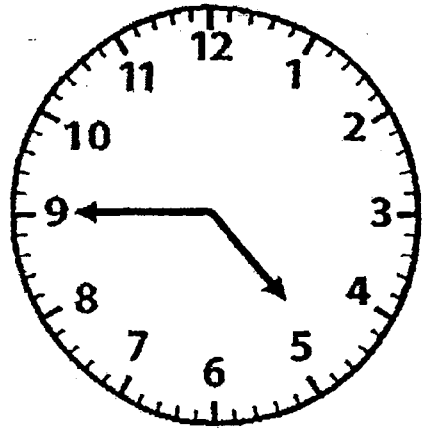

p.m.

20. The Tan family watched a television programme at 3 p.m. It ended at 3.30 p.m. How long was the television programme?

minutes

21. Write the cents in dollars.

5¢ = \$ _____

22. The picture graph shows the number of stamps Amy and her friends collected.

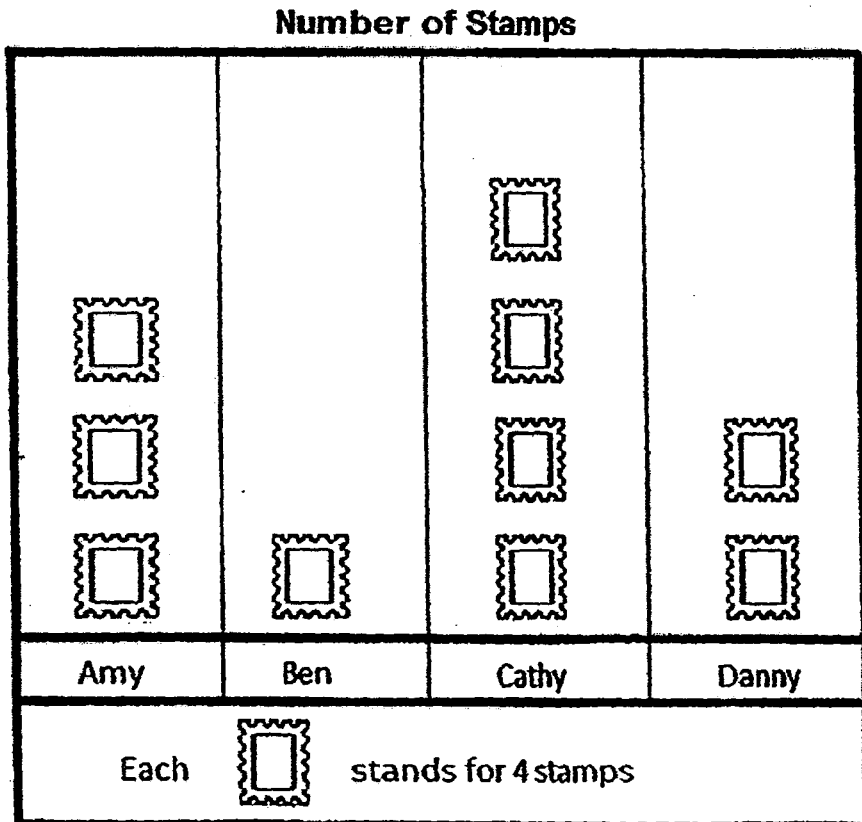

How many stamps did Cathy collect?

stamps

23. What fraction of the figure is shaded?

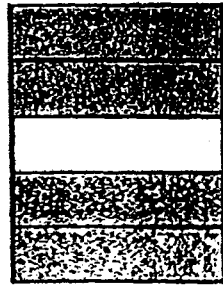

24. Complete the number pattern.



25. Add the following numbers.

$$\begin{array}{r} \text{(a)} \quad 7 \ 6 \ 3 \\ + 1 \ 3 \ 7 \\ \hline \end{array}$$

$$\begin{array}{r} \text{(b)} \quad 4 \ 9 \ 1 \\ + 2 \ 4 \ 0 \\ \hline \end{array}$$

26. Mr Lim had \$680 and Mrs Lim had \$124. How much more money did Mr Lim have than Mrs Lim?

\$

27. Subtract $\frac{2}{9}$ from 1.

28. The picture graph shows the number of books the children read in a month.

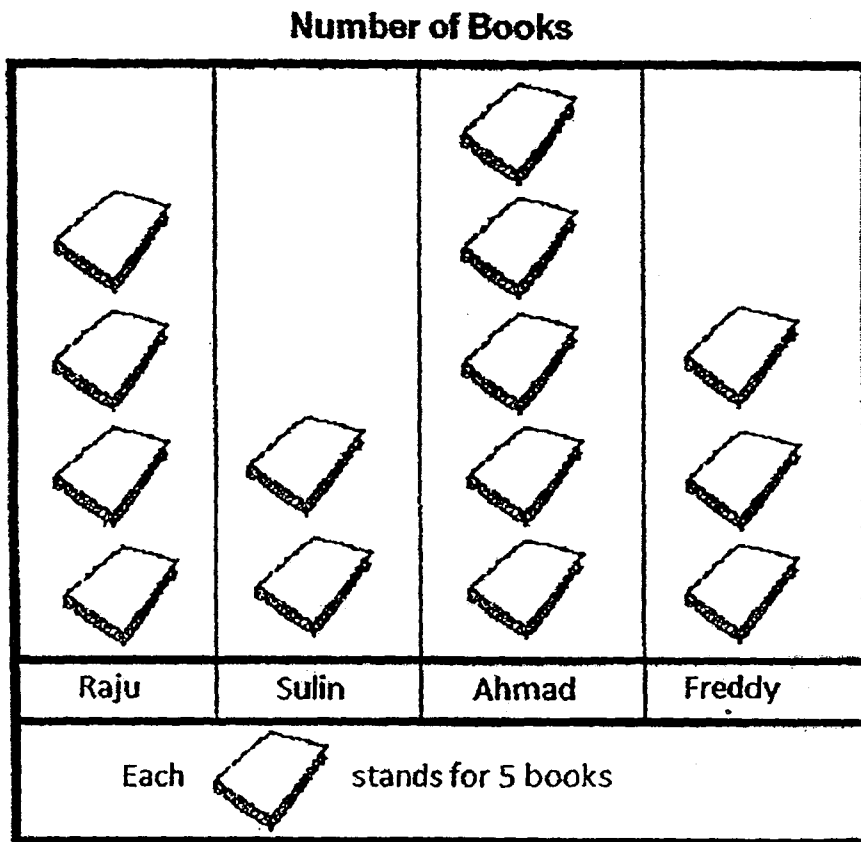

How many books did Sulin and Freddy read altogether?

books

29. Fill in the missing solids that made up the figure.

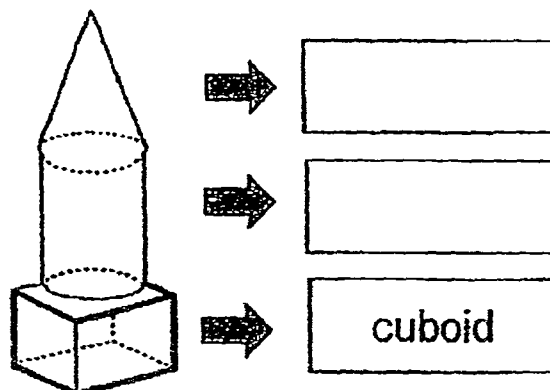

Section C: (Q30 to Q32; 3 marks each Total: 9 marks)

**Show all number sentences and working clearly in the spaces provided.
Write the answers in the statements.**

30. Aunt Lucy buys 10 tomatoes a day. She buys the same number of tomatoes for 10 days.

(a) How many tomatoes does Aunt Lucy buy altogether?

She buys _____ tomatoes altogether.

(b) After buying the tomatoes, Aunt Lucy gives 45 tomatoes away.
How many tomatoes does she have left?

She has _____ tomatoes left.

31. Ali has 384 stamps in his collection. He has 166 more stamps than Gopal.
How many stamps do Ali and Gopal have altogether?

They have _____ stamps altogether.

32.

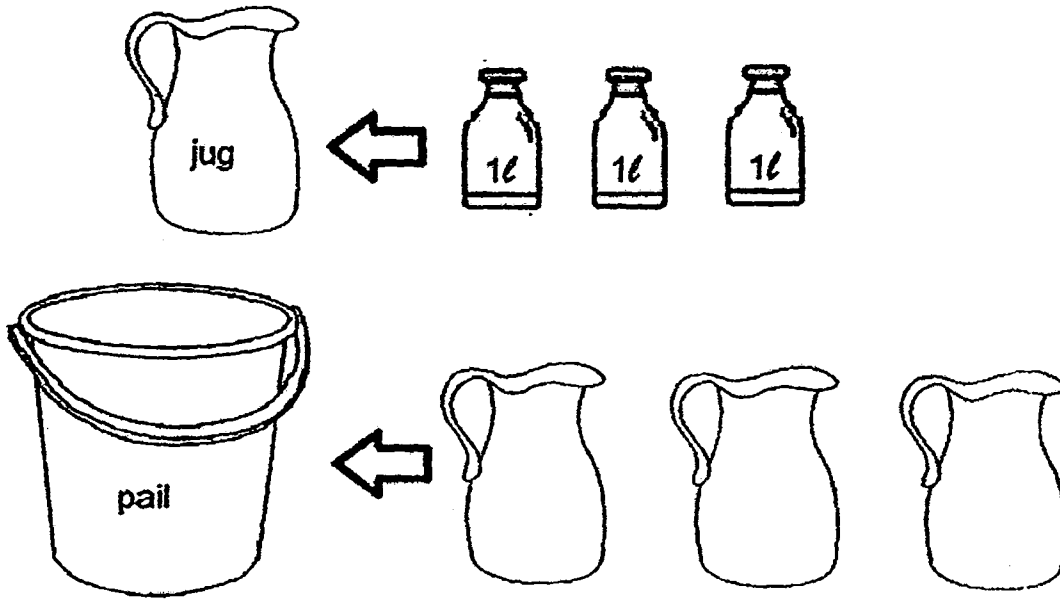

(a) How much water can the pail hold?

The pail can hold _____ litres of water.

(b) Mary uses 2 litres of water in the pail for cooking. How many litres of water are left in the pail?

_____ litres of water are left in the pail.

-----The End-----



ANSWER SHEET

EXAM PAPER 2017(P2)

SCHOOL : RAFFLES GIRLS'

SUBJECT : MATHEMATICS

TERM : SA2

Q1	Q2	Q3	Q4	Q5	Q6	Q7	Q8	Q9	Q10
2	3	3	3	1	3	2	1	4	3
Q11	Q12	Q13	Q14						
4	1	2	3						

15) eight hundred and forty – three 16) 24 17) 7 18) 4 L

19) 4.45 p.m. 20) 30 21) \$0.05 22) 16 stamps 23) 4/5

24) 408 / 348 25) a) 900 b) 731 26) \$556 27) 7/9

28) 25 books 29) cone / cylinder / cuboid

30) a) $10 \times 10 = 100$

She buy 100 tomatoes altogether.

b) $100 - 45 = 55$

She has 55 tomatoes left.

31) $384 - 166 = 218$

$218 + 384 = 602$

They have 602 stamps altogether.

32)a) $3 \times 3 = 9$

The pail can hold 9 litres of water.

b) $9 - 2 = 7$

7 litres of water are left in the pail.

RIVER VALLEY PRIMARY SCHOOL
SEMESTRAL ASSESSMENT 2
2017
PRIMARY TWO
MATHEMATICS

Instructions to candidates

- Do not open the booklet(s) until you are instructed to do so.
- Read all instructions provided in each section carefully.
- Show your workings clearly as marks may be awarded.

Name: _____ ()

Class: Primary 2 ()

Date: 27 October 2017

Duration: 1 hour 30 min

SUMMARY OF MARKS

Section		Questions	Marks Awarded	Maximum Marks
A	Multiple Choice Questions	1 – 13		17
B	Short Answer Questions	14 – 28		20
C	Long Answer Questions	29 – 32		13
Total				50

Parent's Signature: _____

Section A : Multiple-Choice Questions (17 marks)

Questions 1 to 9 carry 1 mark each.

Questions 10 to 13 carry 2 marks each.

For each question, four options are given. One of them is the correct answer. Write your answer (1, 2, 3 or 4) in the brackets provided.

1. 5 hundreds and 8 tens is the same as _____.

(1) 13

(2) 58

(3) 508

(4) 580

()

2. The digit '8' in 782 stands for _____.

(1) 8

(2) 18

(3) 80

(4) 800

()

3. Complete the number pattern.

110, 230, _____, 470, 590, 710

(1) 330

(2) 350

(3) 430

(4) 450

()

4. Which of the following numbers is the smallest?

(1) 503

(2) 530

(3) 305

(4) 350

()

5. Which of the following is the same as 5×4 ?

(1) $4 + 4 + 4 + 4 + 4$

(2) $5 + 5 + 5 + 5 + 5$

(3) $4 \times 4 \times 4 \times 4 \times 4$

(4) $5 \times 5 \times 5 \times 5 \times 5$

()

6. Which of the following fractions is the smallest?

(1) $\frac{1}{2}$

(2) $\frac{1}{8}$

(3) $\frac{1}{7}$

(4) $\frac{1}{5}$

()

7. Look at the 3-D object below. How many flat surfaces does it have?

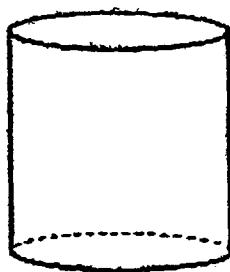

(1) 1

(2) 2

(3) 3

(4) 4

()

8. The length of the ladder is about _____.

(1) 3 cm

(2) 30 cm

(3) 3 m

(4) 30 m

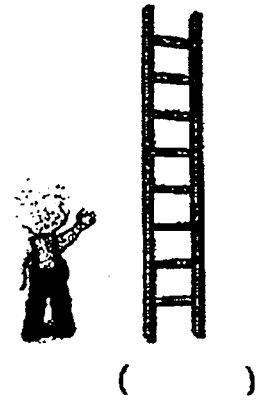

()

9. Which of the following sets of coins has the least amount of money?

A	
B	
C	
D	

(1) A

(2) B

(3) C

(4) D

()

10. What is the time shown on the clock-face below ?

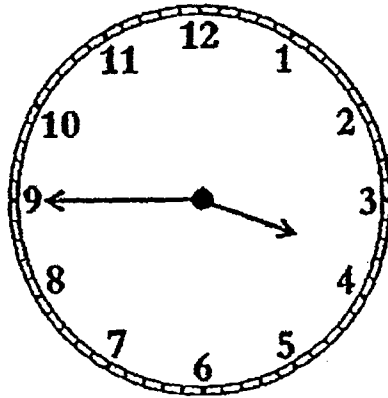

(1) 9.15 p.m.

(2) 9.20 p.m.

(3) 3.45 p.m.

(4) 4.45 p.m.

()

11. Mrs Tan spent \$24 to buy a few pens. Each pen cost \$4.
How many pens did she buy?

(1) 6

(2) 7

(3) 20

(4) 28

()

Section B : Short-Answer Questions (20 marks)

Questions 14 to 23 carry 1 mark each.

Questions 24 to 28 carry 2 marks each.

Write your answer in the space provided.

Show your working clearly as marks may be awarded.

14. $489 + 123 =$ _____.

Answer : _____

15. $750 - 693 =$ _____.

Answer : _____

16. Write seven hundred and thirteen in numerals.

Answer : _____

17. Arrange the numbers below in order, beginning with the smallest.

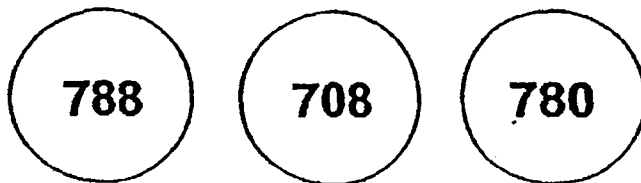

_____ , _____ , _____
smallest

18. 280 is _____ more than 180.

Answer : _____

19. The figure below is made up of similar rectangles.

How many more rectangles must be shaded to show that $\frac{9}{12}$ of the figure is shaded?

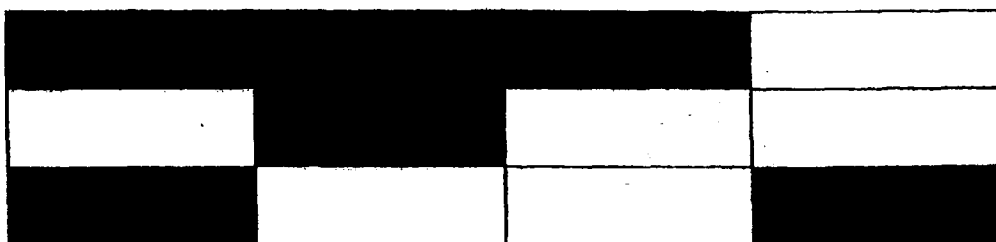

Answer : _____

20. Study the pattern below.
Draw the shape that comes next in the space below.



21. Colour / Circle the coins in the box to make \$2.80.



22. The clock-face below shows the time Tim gets off the train at the train station.
If it took 1 hour for the train to reach its destination, what time would Tim need to get onto the train?

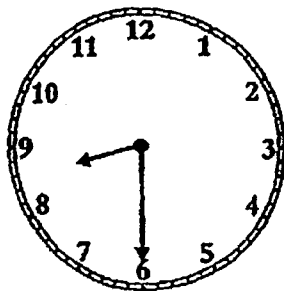

Answer : _____ a.m.

Use the graph below to answer questions 23 and 24.

The graph below shows the number of Mother Tongue and English books read by students from January to June.

Number of books read by students

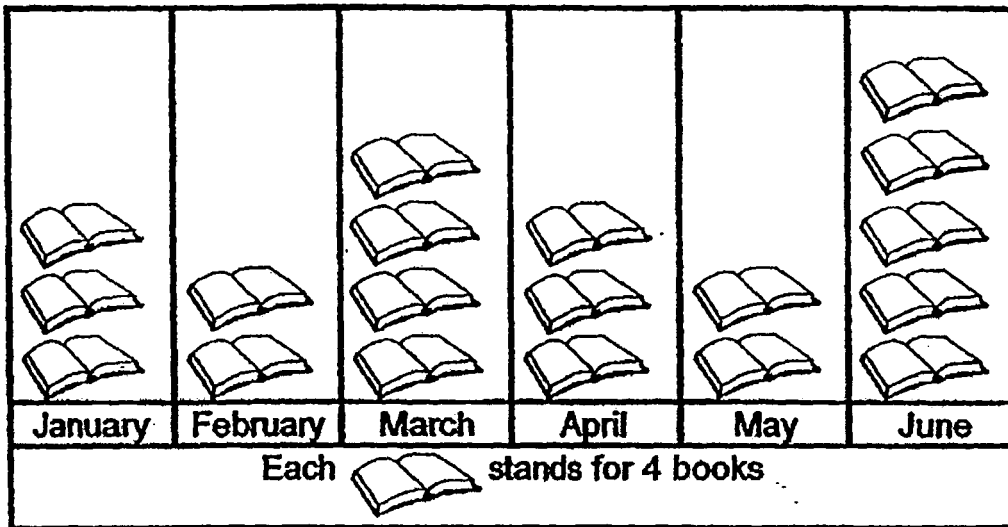

23. How many books were read by the students in June?

Answer : _____

24. The students read a total of 20 Mother Tongue books in March and April. How many English books did they read in the two months?

Answer : _____

25. Study the picture below carefully.
What is the mass of the block?

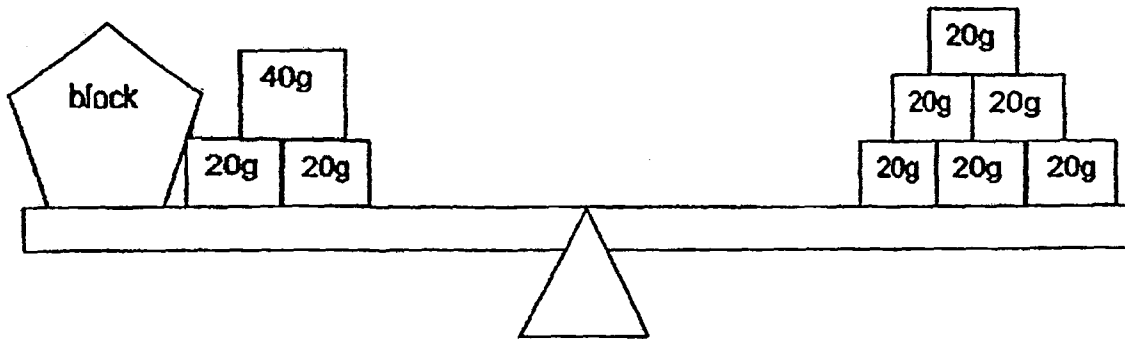

Answer : _____ g

26. Look carefully at the weighing scales below.
What is the mass of Ball A?

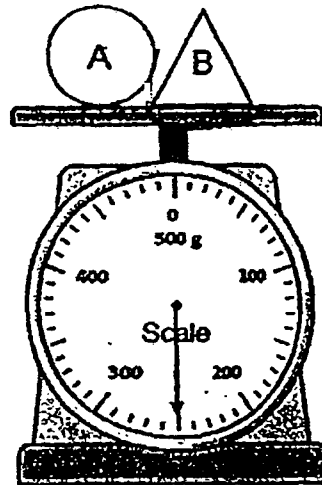
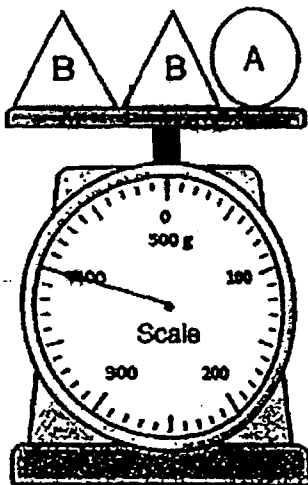

Answer : _____ g

27. Priya had 40 stickers. She gave 8 stickers to her sister.
She put the remaining stickers equally into 4 boxes.
How many stickers were there in each box?

Answer : _____

28. Peter has 278 stamps John has 389 more stamps than Peter.
How many stamps do they have altogether?

Answer : _____

Section C : Long Answer Questions (13 marks)

Questions 29 to 31 carry 3 marks each. Question 32 carries 4 marks. Do these sums carefully. Show your number sentence(s) clearly as marks may be awarded.

29. Tom had a wooden plank which was 90 cm long.
He cut it into 3 parts, A , B and C. Part A was 12 cm long and Part B was 54 cm long.

a) How much longer was Part B than Part A? (1m)

Part B was _____ cm longer than Part A.

b) What was the length of Part C? (2m)

Part C was _____ cm long.

30. Khairul had \$250.

He had \$35 more than Nora.

a) How much money did Nora have? (1m)

Nora had \$_____.

b) Khairul bought 2 shirts. Each shirt cost \$83.

How much money did Khairul have left? (2m)

Khairul had \$_____ left.

31. Luke had a cake.

He gave $\frac{2}{10}$ of the cake to Mary and $\frac{1}{10}$ of the cake to Sarah.

a) What fraction of the cake did Luke give away? (1m)

Luke gave away _____ of the cake.

b) Luke also ate $\frac{3}{10}$ of the cake.

What fraction of the cake did Luke have left in the end? (2m)

Luke had _____ of the cake left in the end.

32. Jack and Jill had a total of 460 books altogether.
Jill had 189 books.

a) How many more books did Jack have than Jill? (2m)

Jack had _____ more books than Jill.

b) Jill has 3 brothers. She gave each brother 10 books.
How many books did Jill have left in the end? (2m)

Jill had _____ books left in the end.

*Have you checked your answers?
- End of Paper -*

ANSWER SHEET

EXAM PAPER 2017(P2)

SCHOOL : RIVER VALLEY

SUBJECT : MATHEMATICS

TERM : SA2

Q1	Q2	Q3	Q4	Q5	Q6	Q7	Q8	Q9	Q10
4	3	2	3	1	2	2	3	3	3
Q11	Q12	Q13							
1	3	3							

14)612

15)57

16)713

17)708, 780, 788

18)100

19)3

20)



21)\$1, \$1, 50¢, 20¢, 10¢

22)7.30 a.m.

23) $5 \times 4 = 20$

24) $12 + 16 = 28$

25)40 g

26)100 g

$$28 - 20 = 8$$

27) $32 \div 4 = 8$

28) $389 + 278 = 667$

$$667 + 278 = 94$$

29)a) $54 - 12 = 42$

Part B was 42 cm longer than Part A.

29)b) $54 + 12 = 66$

$90 - 66 = 24$

Part C was 24 cm long.

30)a) $250 - 35 = 215$

Nora had \$215.

b) $83 + 83 = 166$

$250 - 166 = 84$

Khairul had \$84 left.

31)a) $1/10 + 2/10 = 3/10$

Luke gave away $3/10$ of the cake.

b) $10/10 - 3/10 = 7/10$

$7/10 = 3/10 + 4/10$

Luke had $4/10$ of the cake left in the end.

32)a) $271 - 187 = 82$

Jack had 82 more books than Jill.

b) $189 - 30 = 159$

Jill had 159 books left in the end.



Established since 1930

RULANG PRIMARY SCHOOL

Nurturing Competencies, Inspiring Excellence, Empowering Individuals
Scholars of Tomorrow

Name : _____ ()

Level : Primary Two

Class : Primary 2 _____

Date : 27 October 2017

END OF YEAR REVIEW 2017 MATHEMATICS

PAPER 1

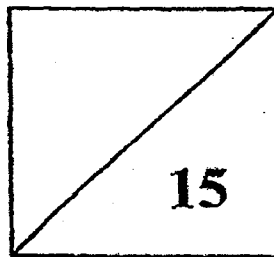

TOTAL TIME FOR PAPER 1: 20 minutes

15 questions

15 marks

- DO NOT OPEN THIS BOOKLET UNTIL YOU ARE TOLD TO DO SO.
- READ ALL THE INSTRUCTIONS CAREFULLY.
- ANSWER ALL THE QUESTIONS.

Questions 1 to 10 carry 1 mark each. For each question, four options are given. One of these is the correct answer. Make your choice and write its number (1, 2, 3 or 4) in the bracket provided.

(10 marks)

1. Which of the following is the same as $9 + 9 + 9$?

(1) 3 threes

(2) 3 nines

(3) 9 threes

(4) 9 nines

()

2. Which of the following fractions is the smallest?

(1) $\frac{1}{8}$

(2) $\frac{1}{7}$

(3) $\frac{1}{6}$

(4) $\frac{1}{5}$

()

3. What fraction of the figure below is shaded?

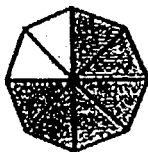

(1) $\frac{2}{6}$

(2) $\frac{6}{6}$

(3) $\frac{2}{8}$

(4) $\frac{6}{8}$

()

4. If  is $\frac{1}{3}$, which of the following figures shows 1 whole?

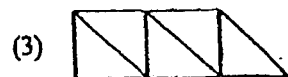

()

5. The time now is 10.40 a.m. Which number should the missing minute hand be pointing at?

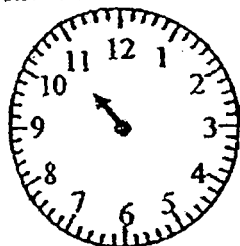

(1) 8

(2) 2

(3) 10

(4) 4

()

6. What time does the clock show?

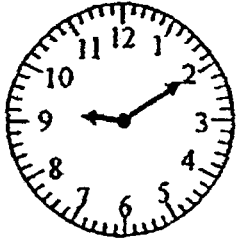

(1) 1.45 p.m.

(2) 2.45 p.m.

(3) 9.10 p.m.

(4) 10.10 p.m.

()

7. How many 2-litre bottles of water are needed to fill up an empty 10-litre pail completely?

(1) 5

(2) 8

(3) 10

(4) 12

()

8. The pictures below show the number of containers of water needed to fill each pot completely. Which pot will hold the most amount of water?



(1)

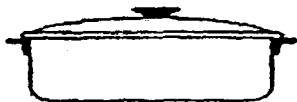

(2)

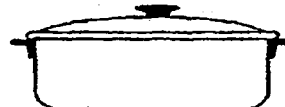

(3)



(4)



()

Questions 11 to 15 carry 1 mark each. Show your working clearly in the space below each question and write your answers in the spaces provided. For questions which require units, give your answers in the units stated. (5 marks)

11. $\frac{3}{10}$ and make 1 whole.

What is the missing fraction in the box above?

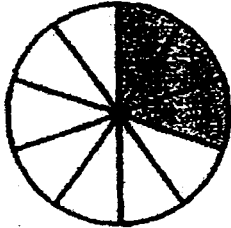

1 Whole

Ans:

12. Draw the minute hand on the clock face to show 6.25 p.m.

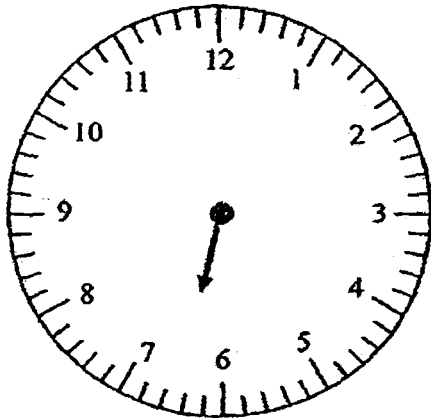

13. How many hours are there between noon and 3 p.m.?

Ans:

h

The picture graph below shows the favourite subjects of a group of pupils.
Study the picture graph and answer Questions 14 and 15.

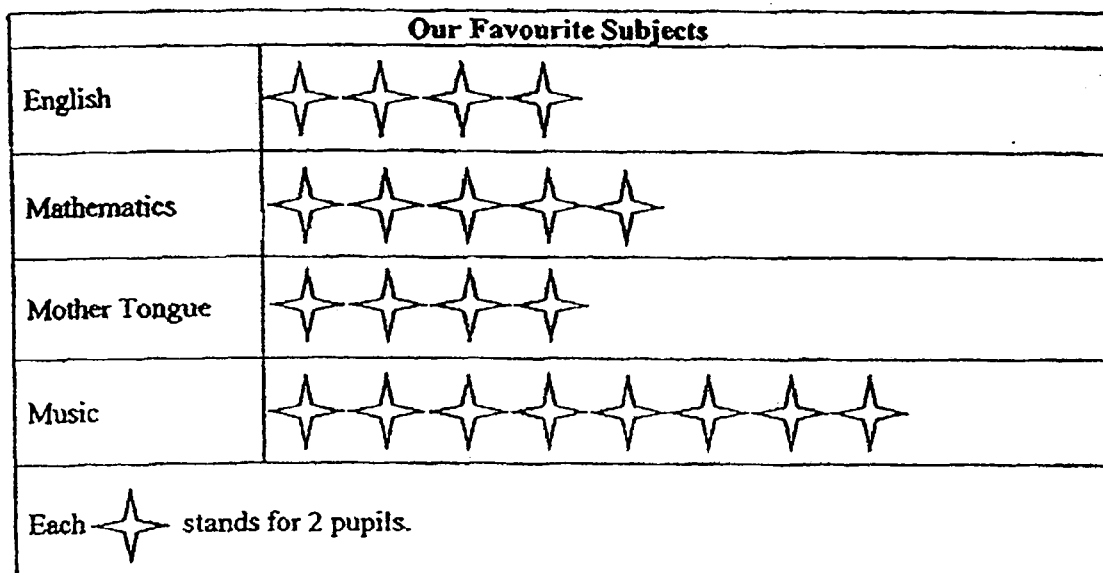

14. Which was the pupils' most favourite subject?

Ans:

15. How many pupils chose English as their favourite subject?

Ans:

End-of-Paper 1



Established since 1930

RULANG PRIMARY SCHOOL

Nurturing Competencies, Inspiring Excellence, Empowering Individuals
Scholars of Tomorrow

Name : _____ ()

Total Marks
Papers 1 & 2

Level : Primary Two

Class : Primary 2 _____

Date : 27 October 2017

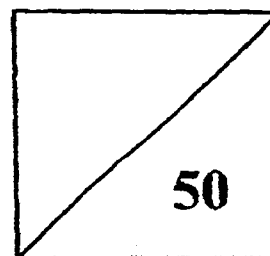

END OF YEAR REVIEW 2017 MATHEMATICS

PAPER 2

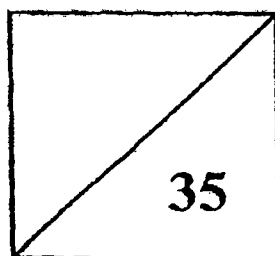

TOTAL TIME FOR PAPER 2: 50 minutes

15 questions

35 marks

- DO NOT OPEN THIS BOOKLET UNTIL YOU ARE TOLD TO DO SO.
- READ ALL THE INSTRUCTIONS CAREFULLY.
- ANSWER ALL THE QUESTIONS.

Questions 1 to 10 carry 2 marks each. Show your working clearly in the space below each question and write your answers in the spaces provided. For questions which require units, give your answers in the units stated. (20 marks)

1. $\frac{2}{7} + \frac{3}{7} = \boxed{\quad ? \quad}$

What is the missing fraction in the box above?

Ans:

2. Subtract $\frac{1}{4}$ from 1.

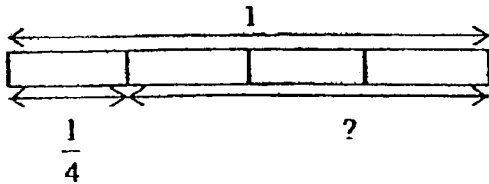

Ans:

3. Arrange the fractions below in order. Begin with the greatest fraction.

$\frac{5}{9}, \frac{3}{9}, \frac{7}{9}$

Ans: , ,
greatest

4. Where should the missing minute hand be pointing at? Draw the missing minute hand on the clock face below.

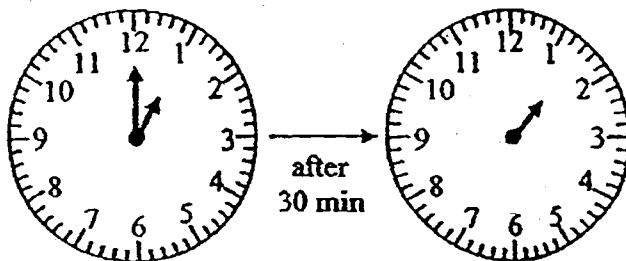

5. What time does the clock below show?



Ans:

p.m.

The picture graph below shows the number of pupils with different CCAs in Primary 3A. Study the picture graph and answer Questions 6, 7 and 8.

Number of pupils in each CCA	
Art Club	▲ ▲
Badminton	▲
Softball	▲
Wushu	▲ ▲ ▲ ▲
Each ▲ stands for 5 pupils.	

6. How many pupils from Wushu should join the Art Club so that the number of pupils in both CCAs is the same?

Ans:

7. Last Monday, all the Softball members did not turn up for CCA. How many pupils were present for CCA last Monday?

Ans:

8. 5 pupils are allowed to take up a second CCA. They join the Badminton CCA. What is the total number of pupils in the Badminton CCA now?

Ans:

9. Alice has her breakfast at 7.30 a.m.
Bala has his breakfast 1 hour later than Alice.
What time does Bala have his breakfast?

Ans: a.m.

10. Aini has 5 l of grape juice and 3 l of apple juice.
How many more litres of grape juice than apple juice does she have?

Ans: l

Questions 11 to 15 carry 3 marks each. Show your working clearly in the space provided for each question as marks will be awarded for relevant statements and correct answers. (15 marks)

11. Jack buys 8 packets of biscuits.
Each packet has 5 biscuits in it.
How many biscuits are there altogether?

-
12. Rubear Kindergarten has 450 pupils.
260 of them are boys.
How many girls are there?
-

13. John's family used 250 l of water in August.
This was 75 l of water less than the amount of water used in September.
How many litres of water did his family use in September?

-
14. Kelvin has 24 l of fruit juice.
He wants to fill up as many 3-litre bottles completely with fruit juice as possible.
How many 3-litre bottles does he need?
-

15. Mrs Lim bought 24 blueberry tarts and some strawberry tarts.
After giving 5 strawberry tarts to her neighbour, she had an equal number of blueberry and strawberry tarts left.
- (a) Did she buy more blueberry or strawberry tarts? [1 mark]

She bought more _____ tarts.

- (b) How many strawberry tarts did she buy? [2 marks]

End-of-Paper

ANSWER SHEET

EXAM PAPER 2017(P2)

SCHOOL : RULANG

SUBJECT : MATHEMATICS

TERM : SA2

Q1	Q2	Q3	Q4	Q5	Q6	Q7	Q8	Q9	Q10
2	1	4	1	1	3	1	2	2	3

11) 7/10

12)



13) 3 h

14) Music

15) 8

Paper 2

1) 5/7

2) $\frac{3}{4}$

3) 7/9, 5/9, 3/9

4)

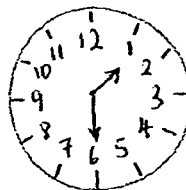

5) 11.10 p.m.

6) 5

7) 35

8) 10

9) 8.30 a.m.

10) 2 L

11) $8 \times 5 = 40$

Jack bought 40 biscuits altogether.

12) $450 - 260 = 190$

There are 190 girls.

13) $250 + 75 = 325$

They use 325 litres in September.

14) $24 \div 3 = 8$

He needs 8 3 – litre bottles.

15)a) Strawberry

b) $24 + 5 = 29$

She bought 29 strawberry tarts.



PRIMARY 2 END-OF-YEAR EXAMINATION 2017

Name : _____ () Date: 26 October 2017

Class : Primary 2 ()

Time: 7.50 a.m. – 8.50 a.m.

Parent's Signature : _____

Marks: _____ / **50**

MATHEMATICS

INSTRUCTIONS

1. Write your name, class and register number.
2. Do not turn over this page until you are told to do so.
3. Follow all instructions carefully.
4. Answer all questions.

Section A (5 x 1 mark)

Choose the correct answer and write its number in the brackets.

1. In the number 684, the digit 6 stands for _____.

- (1) 6 tens
- (2) 6 ones
- (3) 60 tens
- (4) 60 ones

()

2. Subtract 395 from 804. The answer is _____.

- (1) 405
- (2) 409
- (3) 519
- (4) 591

()

3. What is the total amount of money shown below ?

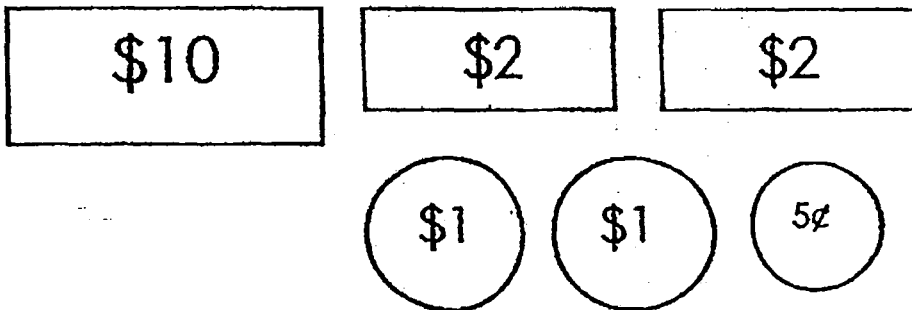

- (1) \$14.05
- (2) \$14.25
- (3) \$16.05
- (4) \$16.25

()

4. $350 + 150 = \underline{\hspace{2cm}} - 125$

(1) 375

(2) 400

(3) 500

(4) 625

()

5. What fraction of the figure needs to be shaded to make 1 whole?



(1) $\frac{6}{10}$

(2) $\frac{4}{10}$

(3) $\frac{4}{6}$

(4) $\frac{2}{6}$

()

Section B

Questions 6 to 15 carry 1 mark each.

Questions 16 to 25 carry 2 marks each.

Fill in the blanks or boxes with the correct answer.

6. Write in words.

827	
------------	--

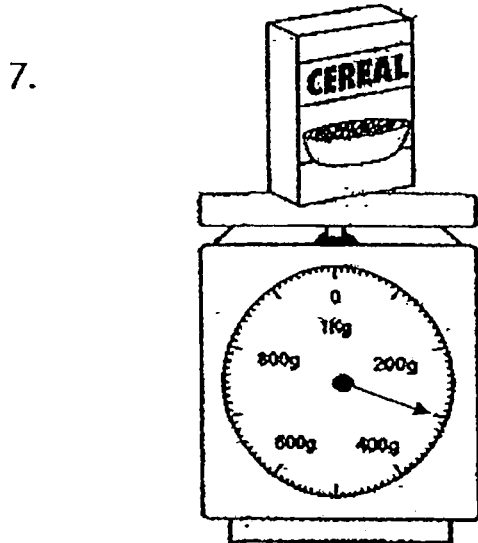

The mass of the box of cereal

is g.

8. Colour $\frac{5}{8}$ of the figure below.

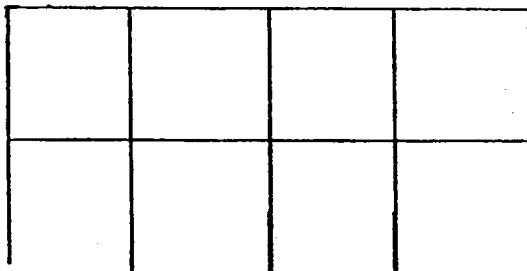

9. Arrange the fractions in order, beginning with the greatest.

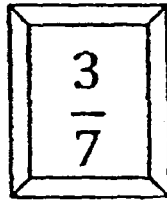
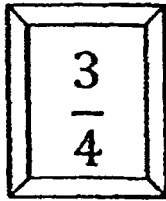
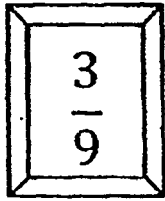

_____ / _____ / _____ / _____
Greatest

10. Circle the figure that is made up of a triangle and a semicircle.

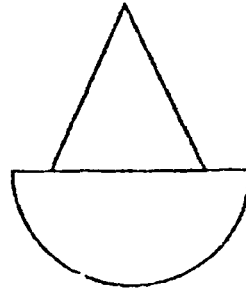
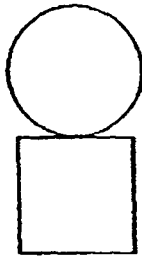
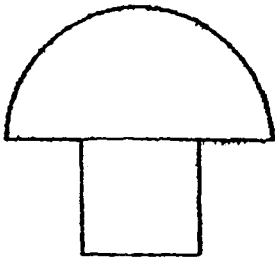

11. Look at the picture below.
 Then write a multiplication equation.

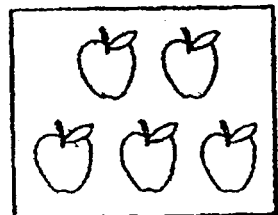
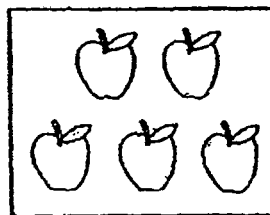
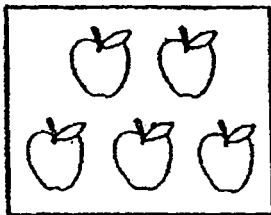
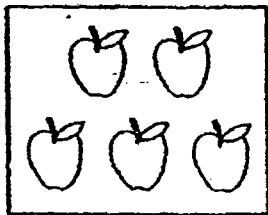

□ ○ □ = □

12. If $\star + \star + \star + \star + \star + \star = 18,$

\star stands for

13. Look at the figure below. How many flat surfaces are there?

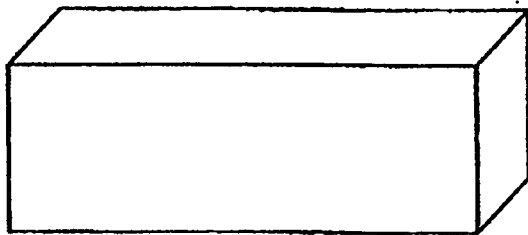

There are flat surfaces.

14.

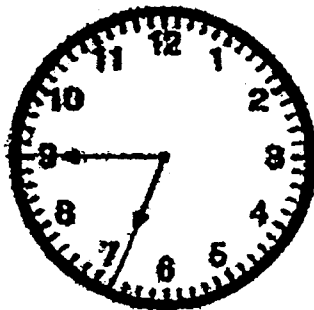

The time shown on the clock is _____ p.m.

15. Find the amount of water needed to fill up the tank to 50ℓ.

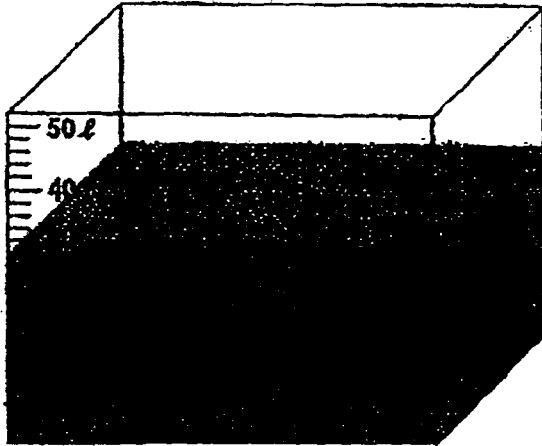

The amount of water needed is ℓ.

16. Collin bought a cupcake, 2 ice-cream cones and a cookie.
How much did he pay?



Cupcake
\$1.50 each



Ice Cream
\$2 each

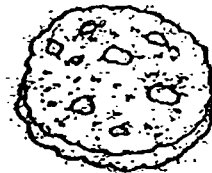

Cookie
\$0.80 each

He paid \$

- 17.

$$\begin{array}{r} 6 \square 8 \\ + 265 \\ \hline 923 \\ \hline \end{array}$$

18. The picture shows a pencil and a crayon.

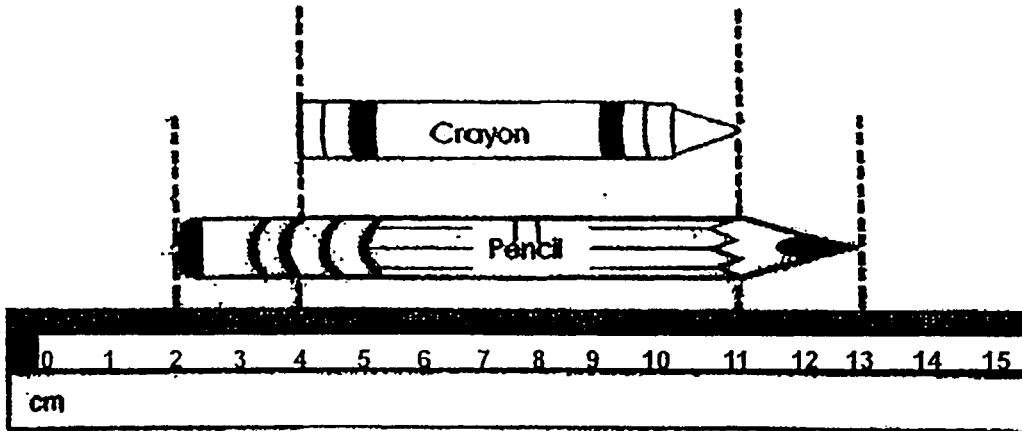

The pencil is cm longer than the crayon.

19. Sam ran 2 rounds around the school field. How far did he run ?

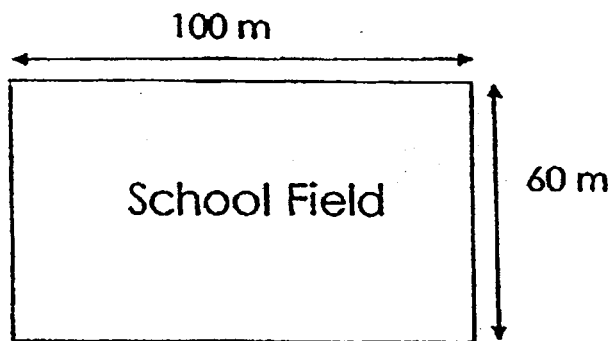

He ran m.

20. Circle the missing shape in the box.

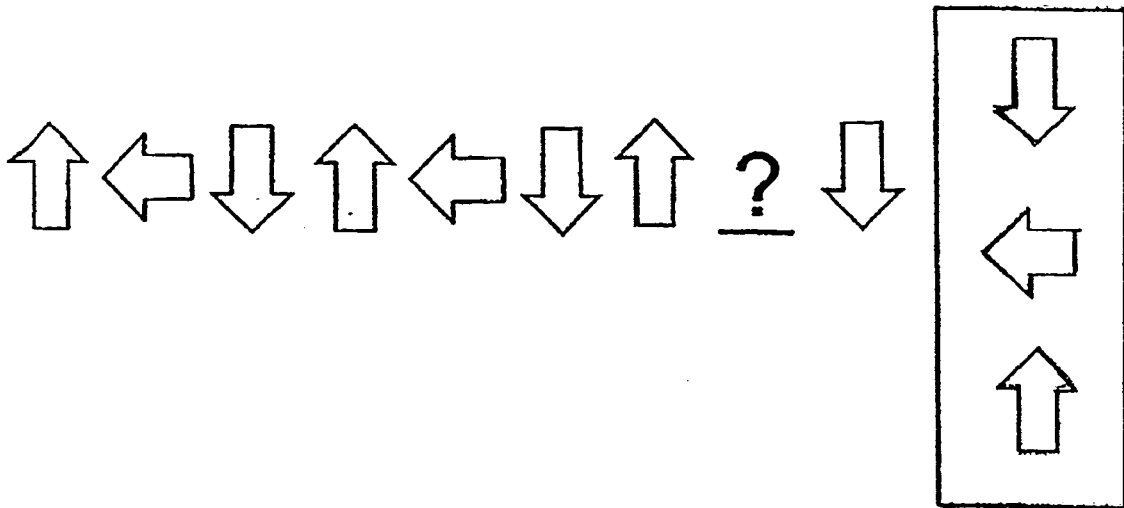

21. Max reached the library at 2 p.m.
He stayed there for 1 h 30 min before leaving.
What time did he leave the library ?

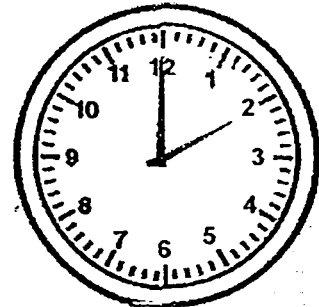

Max left the library at p.m.

22.

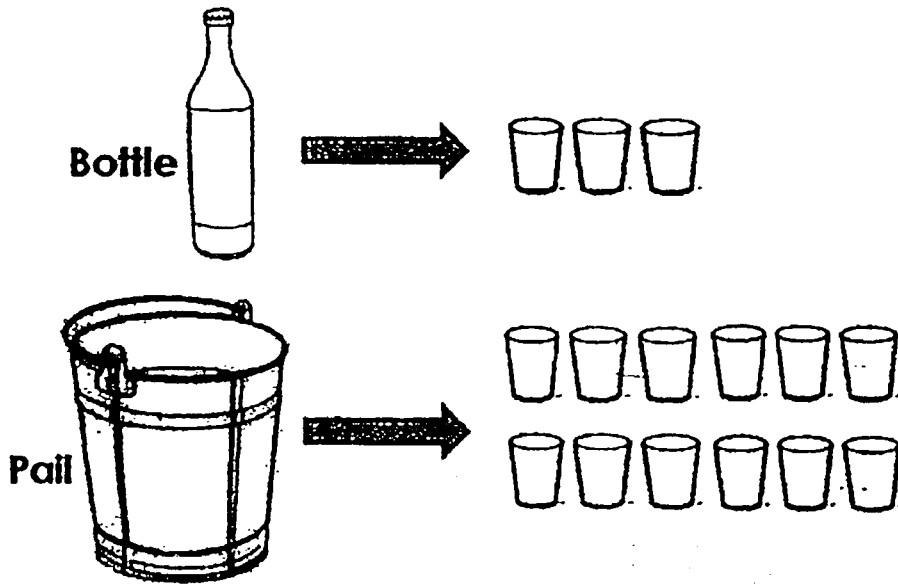

3 glasses of water is needed to fill up 1 bottle.

A pail will need bottles of water to fill it completely.

23. The picture below shows 4 boxes, A, B, C and D of different mass.

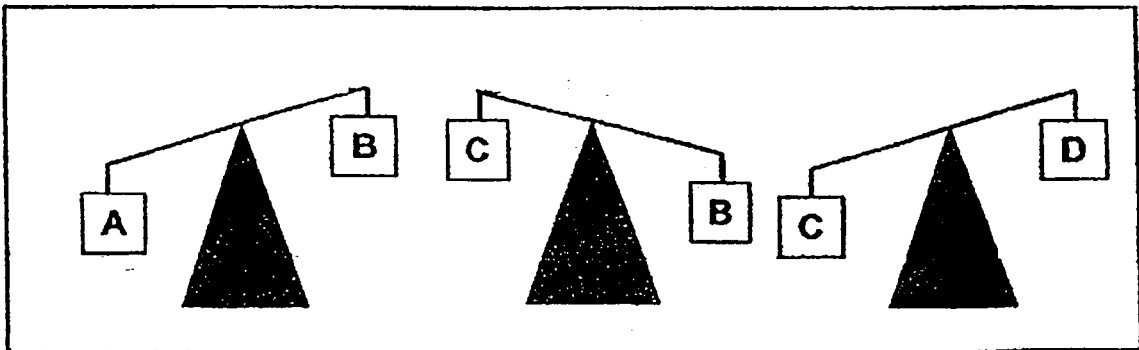

Box is the heaviest.

The picture graph shows the favourite fruit of students in Class 2N.
Use it to answer questions 24 and 25.

Our Favourite Fruits

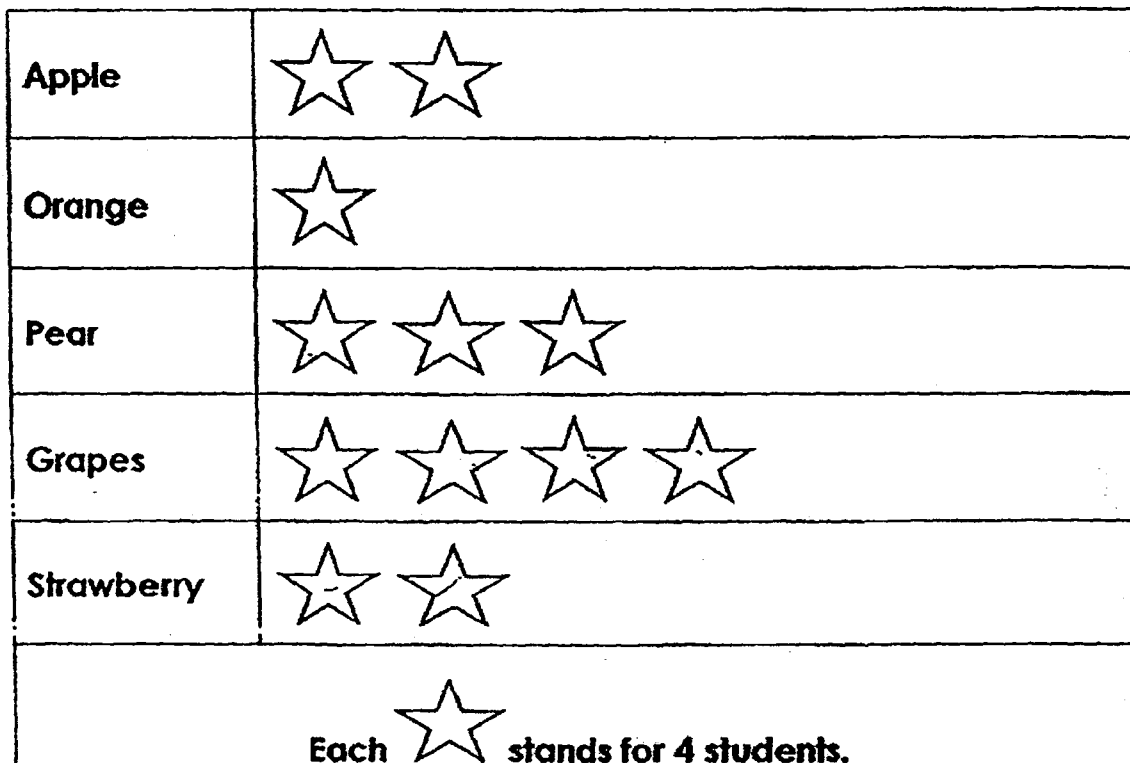

24. more students like pears than oranges.

25. The total number of students who like apples and strawberries is the same as the number of students who like

Section C (5 x 3 marks)

Read the questions carefully.

Show your number equations and working clearly.

26. Mrs Lim baked 287 cupcakes on Saturday.
She baked 119 fewer cupcakes on Sunday.
How many cupcakes did she bake on both days ?

Mrs Lim baked _____ cupcakes on both days.

27. Mrs Tan bought 3 boxes of buns
There were 10 buns in each box.
She put the buns equally on 5 plates.
How many buns were there on each plate ?

There were _____ buns on each plate .

28. A bar of chocolate cost \$3 and a lollipop cost \$2.
David wanted to buy the same number of chocolates and lollipops.
When he spent \$12 on lollipops, how much did he spend on chocolates ?

You have to complete the table below to show your workings.

Chocolates	\$3						
Lollipops	\$2						

He spent \$ _____ on chocolates.

29. Alex bought 60 ℓ of paint.
He used 30 ℓ to paint the bedrooms and 15 ℓ to paint the kitchen.
How many litres of paint had he left ?

He had _____ ℓ of paint left.

30. Study the patterns below and draw Pattern 4 in the box given.

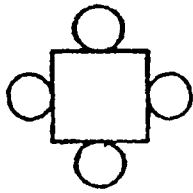

Pattern 1

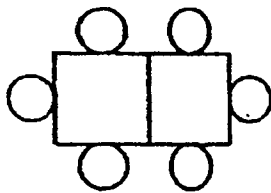

Pattern 2

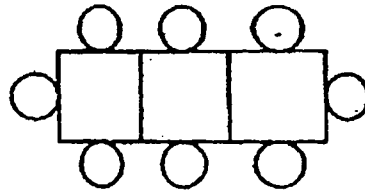

Pattern 3

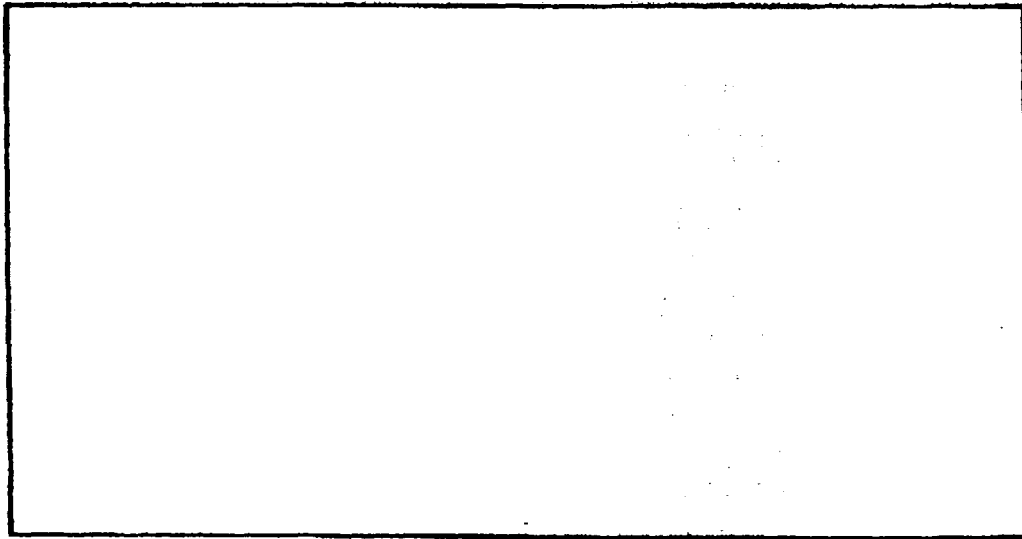

Pattern 4

There are _____ circles and _____ squares in Pattern 4.

End of paper

EXAM PAPER 2017(P2)

SCHOOL : TAO NAN

SUBJECT : MATHEMATICS

TERM : SA2

Q1	Q2	Q3	Q4	Q5
3	2	3	4	1

6) Eight hundred and twenty-seven 7) 300g

9) $\frac{3}{4}$, $\frac{3}{7}$, $\frac{3}{9}$

10)

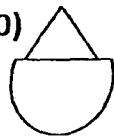

11) $4 \times 5 = 20$

8)

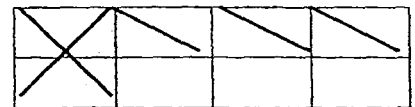

12) 3

13) 6

14) 6.45 p.m.

15) $50 - 30 = 20L$

16) \$6.30

17) 5

18) 4

19) 640 m

20)

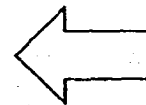

21) 3.30 p.m.

22) 4

23) A

24) 8

25) Grapes

26) $287 - 119 = 168$

$$287 + 168 = 455$$

Mrs Lim baked 455 cupcakes on both days.

27) $10 \times 3 = 30$

$$30 \div 5 = 6$$

There were 6 buns on each plate.

28) He spent \$18 on chocolates.

29) $30 + 15 = 45$

$60 - 45 = 15$

He had 15 L of paint left.

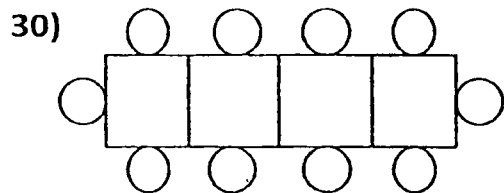

There are 10 circles and 4 squares in Pattern 4.